



# Scholar QR

## VDH/VAH Heat Pumps & VDH/VAH Air Conditioners

**INSTALLATION AND START-UP**

**Models VDH2036/2040 & VAH2030/2048**  
**2.5 to 4 Ton Cooling Capacity with 2-Stage Compressors**

**⚠ WARNING**  
**SAFETY REQUIREMENTS**

- If the information in these instructions are not followed exactly, a fire may result causing property damage, personal injury or loss of life.
- Read all instructions carefully prior to beginning the installation. Do not begin installation if you do not understand any of the instructions.
- Improper installation, adjustment, alteration, service or maintenance can cause property damage, personal injury or loss of life.
- Installation and service must be performed by a qualified installer or service agency in accordance with these instructions and in compliance with all codes and requirements of authorities having jurisdiction.
- Follow all safety codes.



MODEL NO.: \_\_\_\_\_  
DATE OF START-UP.: \_\_\_\_\_

SERIAL NO.: \_\_\_\_\_

*Manufactured By:*

**Marvair, An AirX Climate Solutions Brand**

P.O. Box 400 • Cordele, Georgia 31010 • 156 Seedling Drive • Cordele, Georgia 31015  
(229) 273-3636 • Fax (229) 273-5154

[www.Marvair.com](http://www.Marvair.com)

The most current version of this manual can be found at [www.Marvair.com](http://www.Marvair.com).

## How To Use This Manual

This manual is intended to be a guide to the Marvair® VDH/VAH Scholar QR line of vertical packaged heat pumps and air conditioners. This manual covers the installation and start-up of the Scholar QR heat pumps and air conditioners, models VDH/VAH, with two stage compressors. It contains installation, troubleshooting, maintenance, warranty, and application information. The information contained in this manual is to be used by the installer as a guide only. This manual does not supersede or circumvent any applicable national or local codes.

If you are installing the Scholar QR heat pump or air conditioner, first read the entire manual and Appendices for any of the options and accessories before beginning the installation. The Appendices describe the installation of the base stand, the plenum, trim strips, wall brackets and outdoor louvers.

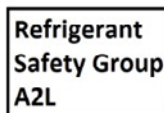
If a malfunction occurs, follow this troubleshooting sequence:

1. Make sure you understand how the Scholar QR unit works.
2. Identify and correct installation errors.
3. If you are still unable to correct the problem, contact the Factory at 1-800-841-7854 for additional assistance.

**Please read the following “Important Safety Precautions” before beginning any work. Failure to follow these rules may result in death, serious bodily harm, property damage and damage to the equipment.**

## Important Safety Precautions


1. This unit uses an A2L, or mildly flammable, refrigerant. Extra precautions should be taken when handling or servicing the unit so as not to puncture the refrigerant tubing.



**WARNING - Risk Of Fire. Flammable Refrigerant Used.  
To Be Repaired Only By Trained Service Personnel. Do  
Not Puncture Refrigerant Tubing.**

**WARNING - Risk Of Fire. Dispose Of Properly In  
Accordance With Federal Or Local Regulations.  
Flammable Refrigerant Used.**

2. LEAK DETECTION SYSTEM Installed. Unit must be powered on except for service.
3. FULLY EVACUATE the system and verify that there is no refrigerant in the working area before brazing.
4. USE CARE when LIFTING or TRANSPORTING equipment.
5. TRANSPORT the UNIT UPRIGHT. Laying it down on its side may cause oil to leave the compressor and breakage or damage to other components.
6. TURN ELECTRICAL POWER OFF AT THE breaker or fuse box BEFORE installing or working on the equipment. LINE VOLTAGES ARE HAZARDOUS or LETHAL.
7. OBSERVE and COMPLY with ALL applicable PLUMBING, ELECTRICAL, and BUILDING CODES and ordinances.
8. DO NOT USE MEANS TO ACCELERATE THE DEFROSTING PROCESS OR TO CLEAN, other than those recommended by the manufacturer.
9. The appliance shall be stored in a room without continuously operating ignition sources (for example: open flames, an operating gas appliance or an operating electric heater).
10. DO NOT PIERCE OR BURN.
11. BE AWARE THAT REFRIGERANTS MAY NOT CONTAIN AN ODOR.
12. SERVICE may be performed ONLY by QUALIFIED and EXPERIENCED PERSONS.
  - \* Wear safety goggles when servicing the refrigeration circuit
  - \* Beware of hot surfaces on refrigerant circuit components
  - \* Beware of sharp edges on sheet metal components
  - \* Use care when recovering or adding refrigerant
13. Use COMMON SENSE - BE SAFETY-CONSCIOUS

This is the safety alert symbol . When you see this symbol on the Marvair unit and in the instruction manuals be alert to the potential for personal injury. Understand the signal word DANGER, WARNING, CAUTION and IMPORTANT. These words are used to identify levels of the seriousness of the hazard.

AS PART OF THE MARVAIR CONTINUOUS IMPROVEMENT PROGRAM, SPECIFICATIONS ARE SUBJECT TO CHANGE WITHOUT NOTICE.  
© 02/2025 Marvair, An AirX Climate Solutions Brand



**DANGER**

Failure to comply will result in death or severe personal injury and/or property damage.



**WARNING**

Failure to comply could result in death or severe personal injury and/or property damage.



**CAUTION**

Failure to comply could result in minor personal injury and/or property damage.



**IMPORTANT**

Used to point out helpful info that will result in improved installation, reliability or operation.

## TABLE OF CONTENTS

### Chapter 1: Description & Specifications

1.1	General Description.....	5
1.2	Model Identification.....	6
1.3	Standard Controls.....	9
1.4	Thermostats And Sub-Bases.....	10
1.5	Optional Controls.....	11

### Chapter 2: Scholar QR Installation

2.1	Tools/Field Furnished Supplies.....	12
2.2	Inspection/Unpacking/Handling.....	12
2.3	Pre Checks.....	13
2.4	Location Selection And Preparation.....	14
2.5	Power And Control Wiring (Rough-In).....	15
2.6	Condensate Drain Line (Rough-In).....	16
2.7	Wet Heat (Rough-In).....	16
2.8	Preparation Of The Scholar QR Heat Pump And Air Conditioner.....	16
2.9	Preparing Scholar QR for Installation.....	19
2.10	Wall Sleeve Field Assembly Steps.....	23
2.11	Installation Through the Outside Wall.....	23
2.12	Condensate Float Switch Functional Check.....	25
2.13	Electrical, Condensate And Wet Heat Hook-Ups.....	25
2.14	Remote Thermostat Installation.....	27

### Chapter 3: Scholar QR Calibration, Controls & HMI Operation

3.1	Ventilation System Calibration.....	32
3.2	PLC Control Adjustments.....	33

### Chapter 4: Scholar QR Networking and Remote Communication

4.1	BACNET Information.....	43
4.2	RS-485 Modbus Serial Port.....	43
4.3	Ethernet Port.....	44

### Chapter 5: Optional Electronic Control Board

5.1	Introduction.....	46
5.2	Installation and Replacement.....	47
5.3	PCB Details and Information.....	47
5.4	Operation.....	51
5.5	Sequence of Operation.....	52

## Chapter 6: Scholar QR Startup

6.1 Start-Up Procedure .....	65
------------------------------	----

## Chapter 7: Service and Charging/Recovery

7.1 Safety Precautions .....	68
7.2 Leak Detection.....	68
7.3 Charging Procedures.....	69
7.4 Refrigerant Recovery.....	69

## Chapter 8: Decommissioning

8.1 Decommissioning .....	71
---------------------------	----

## ILLUSTRATIONS

<b>Figure 1:</b> General External Component Identification and Access to Scholar QR Heat Pump or Air Conditioner.....	5
<b>Figure 2:</b> VDH2024/2036/2040 & VAH2030/2048/2060 Dimensional Data.....	7
<b>Figure 3:</b> VDH2024/2036/2040 & VAH2030/2048/2060 w/Side Panels Removed .....	8
<b>Figure 4:</b> Wall Opening Dimensions for Scholar QR Heat Pump and Air Conditioner .....	14
<b>Figure 5:</b> Dimension Between Scholar QR Heat Pump or Air Conditioner Air Box and Finished Outside Wall for Outdoor Louver/Collar Assembly Installation.....	24
<b>Figure 6a:</b> Remote Wall Mounted Thermostat Wiring Detail.....	28
<b>Figure 6b:</b> Remote Thermostat w/Humidity Controller Wiring Detail .....	28
<b>Figure 7:</b> EMS Wiring Detail.....	29
<b>Figure 8:</b> Ventilation Controls Wiring Detail .....	30
<b>Figure 9a:</b> Typical Control Center Layout for Single-Phase Scholar QR .....	30
<b>Figure 9b:</b> Typical Control Center Layout for 3-Phase Scholar QR .....	31
<b>Figure 10:</b> Electrical Control Box .....	31
<b>Figure 11:</b> Keys and LEDs.....	33
<b>Figure 12:</b> Enthalpy Sensor and Temperature Control Points.....	56
<b>Figure 13:</b> Dry Bulb Sensor.....	57

## TABLES

<b>Table 1:</b> Room Size Limitations and Refrigerant Charge .....	15
<b>Table 2:</b> Altitude Correction Factor .....	15
<b>Table 3:</b> LED Function and Colors.....	34
<b>Table 4:</b> Voltage Limitations.....	66
<b>Table 5:</b> Refrigerant Charge .....	69

## APPENDICES

<b>Appendix A:</b> Wiring Diagrams.....	72
<b>Appendix B:</b> Ratings and Data.....	78
<b>Appendix C:</b> Base Stand Installation.....	79
<b>Appendix D:</b> Installation Of The Freeblow Plenum .....	82
<b>Appendix E:</b> Trim Strip Installation.....	85
<b>Appendix F:</b> Outdoor Louver/Collar Installation .....	86
<b>Appendix G:</b> Electronic Control Board Modbus Map .....	89

# Chapter 1: Description & Specifications

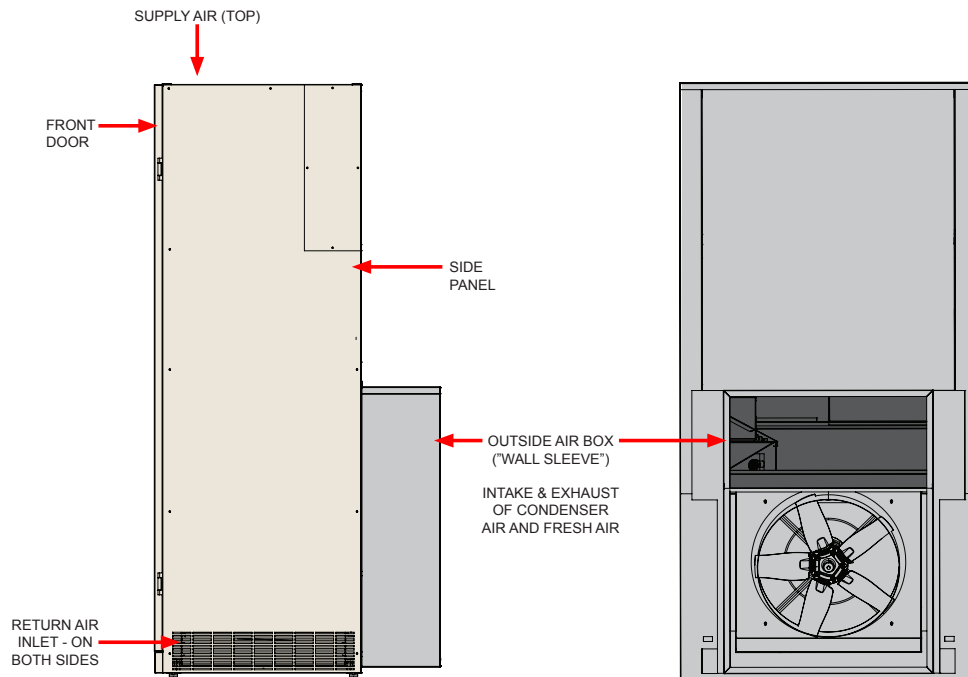
## 1.1 GENERAL DESCRIPTION

The Next Generation Scholar QR VDH and VAH heat pumps and air conditioners from Marvair are modular HVAC systems designed to provide heating, cooling, and outside fresh air for school classrooms. The units are installed in the classroom against an exterior wall. The vertical configuration minimizes the floor space occupied by the HVAC unit. This unique design makes it ideal for both new schools and for renovation of existing classrooms.

A full range of ventilation options are offered to meet any climate or budget. A wide selection of architectural louvers provides the designer with unlimited styles and configurations to compliment the exterior of the school. (For a complete description of the architectural louvers, please refer to the Marvair brochure entitled, "Architectural Extruded Aluminum Louvers".) Marvair offers a full range of thermostats to meet virtually every requirement. The unit can be controlled by a wall mounted thermostat, an internal thermostat or interfaced with a energy management system.

Scholar QR heat pumps and air conditioners are available in cooling capacities from 2.5 to 4 tons with a 2-stage compressor (cooling only) as standard. Electric resistance or hot water is available as primary heat on the air conditioners and as second stage heat on the heat pump. All sizes are available for operation on 208/230 V. 1Ø or 3Ø and 460 V. electrical supply. All models conform to UL/CSA standard 60335-1 and 60335-2-40 and CAN/CSA C22.2, No. 236-11 Ed.4 and listed by ETL.

All models in this manual are equipped with a leak detection system. Once the unit is installed it must be powered, at all times, except for service. During normal operation the leak detection system has no impact on the operation of the unit, however upon detection of R454B refrigerant all operations are stopped except for the indoor blower. The unit will then re-circulate air in the room for a minimum of 5 minutes. Once the 5 minutes have expired and the concentration of the refrigerant is below 8 percent of the Lower Flammability Limit (LFL) the unit will be allowed to operate as normal. If the concentration of the refrigerant remains above 8 percent of the LFL the unit will remain in re-circulation mode. To verify actuation of mitigation simply remove the sensor from the mitigation control board and the system should stop all operation except for the indoor blower. There is no need to calibrate or service the sensor. The sensor will provide an alarm upon failure or end of life. The sensor must be replaced with an identical sensor, or a manufacturer approved alternative.



**Figure 1. General External Component Identification and Access to Scholar QR Heat Pump or Air Conditioner**

## 1.2 MODEL IDENTIFICATION

The identification numbering system for the Scholar QR heat pump and air conditioner system is shown below.

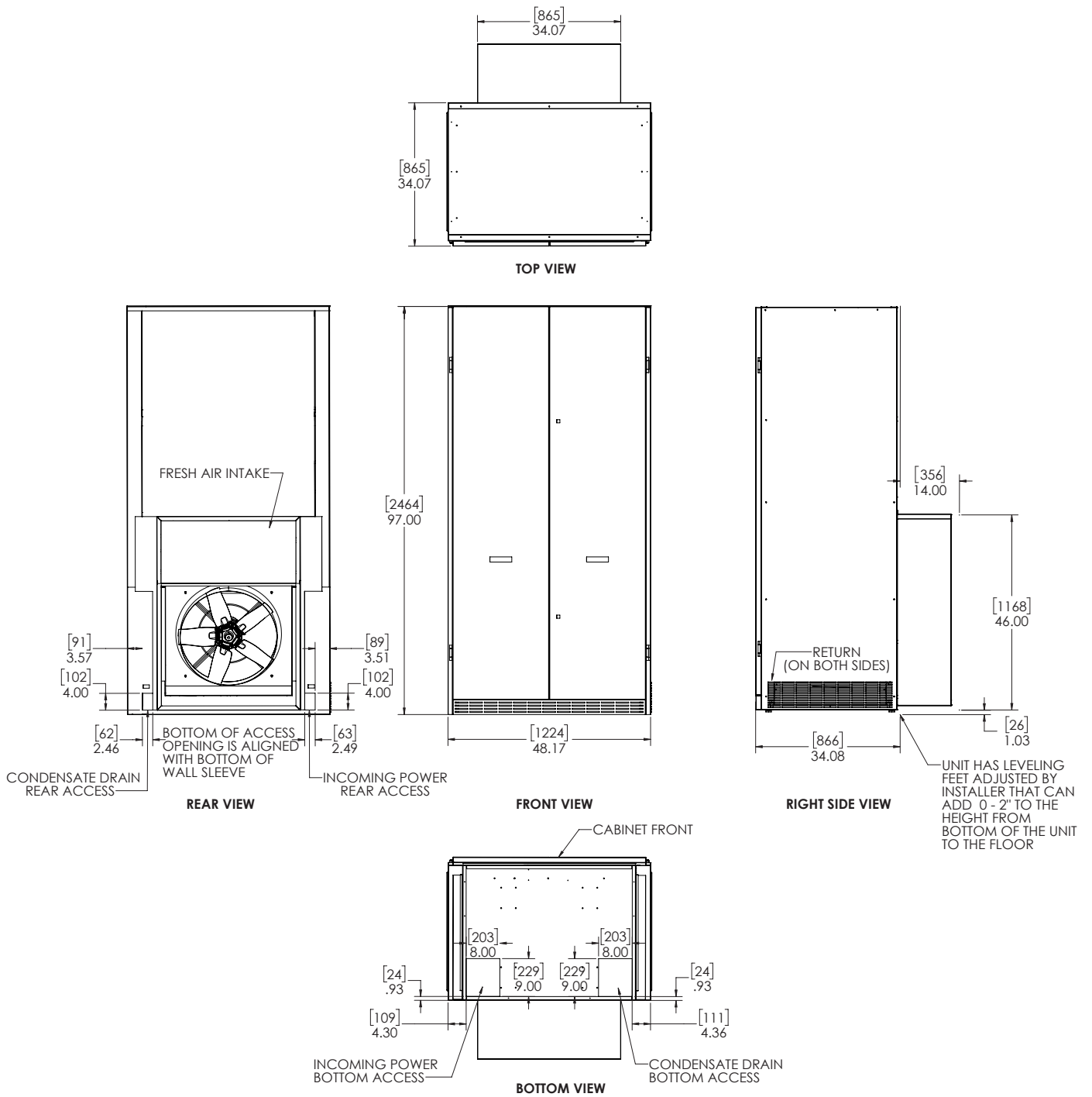
Example	V	D	H	2	0	3	6	A	D	0	5	0	H	G	+	+	+	1	C	A	+	C	1	1	2	+	+	+	+	+
Position	1	2	3	4	5	6	7	8	9	10	11	12	13	14	15	16	17	18	19	20	21	22	23	24	25	26	27	28	29	30

1	Unit Designation/Family	V = Marvair Scholar Classroom Unit	18	Air Flow	C = Top Supply/Front Door Return 1 = Top Supply/Bottom Return	
2	Energy Efficiency Ratio (EER)	A = 11 EER D = 12 EER	19	Compressor Location	E = Right Hand	
3	Refrigerant Type	H = R-454B	20	Filter Option	A = 2" Pleated (MERV 8, AC/HP-C) C = 2" Charcoal D = MERV 11 High Filtration Package E = MERV 13 High Filtration Package + = None	
4	Compressor Type/Quantity	2 = Staged/Step	21	Corrosion Protection	A = Condenser Coil Only C = Evaporator Coil Only D = Both Coils Condenser & Evaporator K = Coastal Package + = None \$ = Special	
5	Unit Capacity/Nominal Cooling (BTUH)	030 = 30,000    040 = 40,000 036 = 36,000    048 = 48,000	22	Engineering	C1	
6			23	Revision Level		
7	System Type	A = Air Conditioner H = Heat Pump	24	Cabinet Color	1 = Marvair Beige (STD) 2 = Gray (STD) 3 = Carlsbad Canyon (STD) 4 = White (STD) 9 = Pebble Gray \$ = Custom Color (Powder Coat)	
8	Power Supply (Volts-Hz-Phase)	A = 208/230-60-1 C = 208/230-60-3 D = 460-60-3	25	Sound Attenuation	2 = Compressor Blanket + = None	
9	Heat Designation @ Rated Voltage KW = Kilowatt	000 = No Heat    100 = 10KW 045 = 4.5KW    120 = 12KW 050 = 5KW       150 = 15KW 060 = 6KW       990 = Hot Water Plenum 080 = 8KW 090 = 9KW	26	Security Option	A = Lockable Access Plate/Tamper Proof + = None	
10			Ventilation Configuration	27	Fastener/Drain Pan Option	C = Stainless Steel Drain Pan + = None
11				Dehumidification	28	Miscellaneous
12	Controls	A = No Ventilation E = Adjustable Fresh-Air w/Powered Pressure Relief & Independent Control N = Manually Adjustable Fresh Intake w/ Fresh Air Filter & Adjustable Pressure Relief Q = GreenCube ERV	29		Unused	A = Double-Wall Front Doors + = None \$ = Special
13			Operating Condition	H = Hot Gas Reheat w/Humidity Control G = Hot Gas Reheat R = Electric Reheat + = None	30	Special Variation
14	Indoor Air Quality Features	H = BACnet w/PLC M = PLC w/ BacNet & Unit Mounted Network Sensor + = None (Green Board)				
15			A = Evaporator Freeze Sensor (EFS) N = Hard Start P = Hard Start w/Low Ambient & CCH R = Crank Case Heater (CCH) 1 = Low Ambient w/FCC 2 = Low Ambient w/FCC & EFS + = None			
16	D = Dry Bulb Sensor E = Dry Bulb Sensor w/Dirty Filter G = Dirty Filter Sensor K = Bi-Polar Ionization + = None					
17						

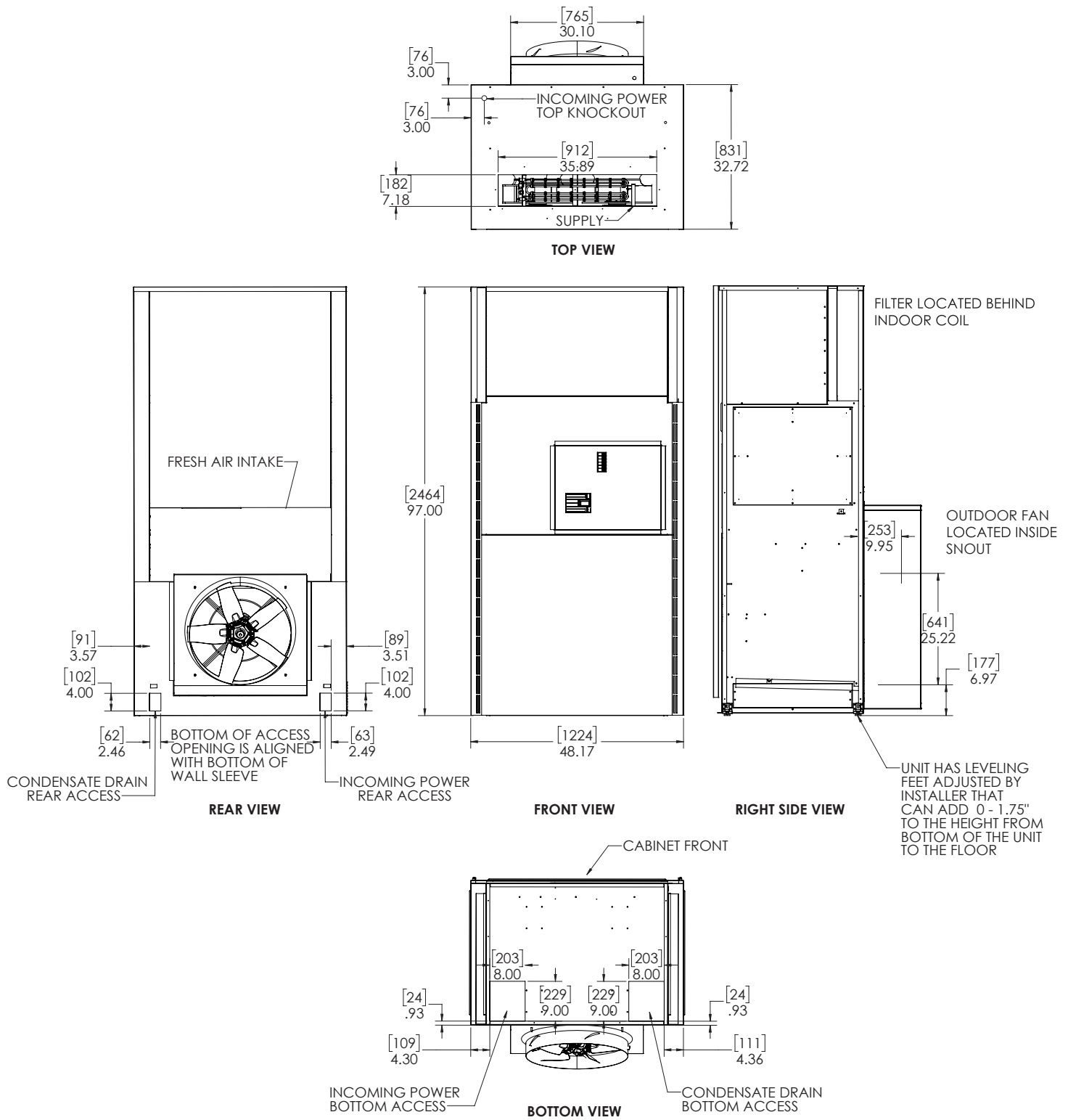
**Note:** Not all options are available with all configurations. Contact your Marvair sales representative for configuration details and feature compatibility.

### Serial Number Date Code

20 = 2020	01 = January	05 = May	09 = September
21 = 2021	02 = February	06 = June	10 = October
22 = 2022	03 = March	07 = July	11 = November
23 = 2023	04 = April	08 = August	12 = December



**Figure 2. VDH2024/2036/2040 & VAH2030/2048/2060 Dimensional Data**



**Figure 3. VDH2024/2036/2040 & VAH2030/2048/2060 w/Side Panels Removed**



## 1.3 STANDARD CONTROLS

### A. Programmable Logic Controller (PLC) Microprocessor

Scholar QR heat pumps and air conditioners use a factory installed PLC microprocessor to control the operation, the safety switches and function options. LED's show operational status and provide assistance with diagnosis if troubleshooting is ever required. Various control functions are field selectable. The PLC is also capable of communicating to PLC's in other Scholar units to allow run time leveling and does not require additional equipment installed in the Scholar QR unit. The PLC microprocessor provides improved reliability because of the reduction of components, the components utilized are more durable and the control box wiring has been simplified. Pertinent statistical data about the life of the refrigeration system can be accessed through the PLC.

The PLC microprocessor provides for the following control and operation functions:

- **Anti-Short Cycle Timer** - Prevents the compressor from destructive short cycling due to momentary power interruptions. One of three time intervals can be field selected.
- **Defrost Timer (heat pumps only)** - Adjustable defrost control that is based upon both time and temperature. The time interval presets are 30, 60 and 90 minutes.
- **BAS Control Relay** - Provides 24 VAC coil to control operation from Building Automation System (BAS). Note - an additional BAS control relay can be added when 120 or 240 VAC coils are required.

### B. High and Low Refrigerant Pressure and Loss of Charge Switches

These switches render the compressor and outdoor fan motor inoperative whenever the limits of the pressure switches are exceeded. In the event of high pressure, the Scholar QR heat pump or air conditioner will turn off the compressor and activate the ASCT.

Low pressure switch is bypassed for 3 minutes during each start-up. After the system has started, if the low pressure and high pressure switch is open while the system is running, the system will fault and the compressor will shut down, which in turn will activate the Anti-Short-Cycle-Timer. Once the ASCT has elapse and the switch(s) resets, if there is still a call for cooling the unit will start back up.

The high and low pressure and loss of charge switches are resettable at the wall thermostat or by turning power off and then on to the Scholar QR heat pump or air conditioner.

**Note:** Scholar units built before 8/23/2021 will no longer use wires and jumper for S-CKT and EHDD. The selection of both features will be done from PLC screen.

### C. Heat Related Controls

The **outdoor thermostat (heat pump only)**, if installed, factory set at 40°F, determines the temperature at which the supplemental electric heat (or wet heat) turns on to heat the classroom. The temperature set point can be adjusted in the field for local conditions. When the outdoor thermostat activates wet heat, the compressor simultaneously turns off.

The **electric heat control** allows the user to select whether the electric heat operates simultaneously with the compressor. Scholar QR units are wired at the

factory to allow simultaneous operation upon a call for electric heat from the system thermostat. Electric heat will only operate:

1. Upon call from thermostat
2. When outdoor thermostat threshold is reached, if installed
3. Or during defrost when set to operate

For non-simultaneous operation, navigate to “Option Selection” screen and turn off EHDD, then turn on S-CKT. Notice that EHDD is now “OFF” and S-CKT is now “Selected”.

The **electric heat during defrost “EHDD” (heat pump only)** allows the user to select whether electric heat operates when the heat pump enters into the defrost mode. The units are set at the factory to allow for electric heat during defrost (EHDD). For operation during defrost, go to “Option Selection” screen to turn on EHDD and turn off S-CKT, S-CKT prevent the compressor and electric heat to operate at the same time.

#### **D. Motorized Fresh Air Damper with PowerVent**

Ventilation options equipped with a **fresh air fan speed control**. The fresh air fan speed control controls the ventilation exhaust fan, automatically balancing the intake and exhaust cfm up to 450 cfm. The intake blower is controlled and can be adjusted from the PLC on the control speed setting screen.

### **IMPORTANT**

**MINIMUM AIR FLOW IS REQUIRED FOR PROPER OPERATION.**

## **1.4 THERMOSTATS AND SUB-BASES**

### **A. Thermostats for Air Conditioners and Heat Pumps with two stages heating.**

1. **Digital, 7 day, 5-2 and 5-1-1 day programmable thermostat.** Two stage heat/Two stage cool. Manual or auto changeover. Fan: Auto & On. Permanent retention of setting on power loss. Field adjustable temperature calibration. Adjustable max. setpoint for heating and min. adjustable setpoints for cooling. Adjustable temperature differential. Keypad lockout. Status LED. °F or °C selectable. Title 24 compliant. For use with models VAIA and VAISA. Marvair P/N 50107.
2. **Digital, 7 day, 2 occupied & 2 unoccupied periods for each day of the week programmable thermostat.** Three stage heat/Three stage cool. Manual or auto changeover. Fan: Auto & On. Ten year retention of programming settings and 48 hour clock and day settings on power loss. Adjustable max. setpoint for heating and min. adjustable setpoints for cooling. Adjustable temperature differential. Keypad lockout. Status LED. °F or °C selectable. Optional remote sensors for outdoor air, supply air and humidity. Title 24 compliant. For use with Scholar QR models. Marvair P/N 50248.
3. **Digital, non-programmable thermostat.** Two stage heat/Two stage cool. Manual or auto changeover. Fan: Auto & On. Permanent retention of setting on power loss. Field adjustable temperature calibration. Adjustable max. setpoint for heating and min. adjustable setpoints for cooling. Adjustable temperature differential. Keypad lockout. Status LED. °F or °C selectable. For use with Scholar QR models. Marvair P/N 50252.

- MAR8000 thermostat.** See Product Data Sheet for complete description.5. The **direct digital control (DDC)** interfaces with the building automation system (BAS) is to be defined by the specifier, in consultation with the Marvair® sales representative. Marvair will factory install the **DDC** sent by the **DDC** manufacturer, and purchased by the customer.

#### **B. Thermostats for air conditioners or heat pumps with only one stage of heating.**

- Digital, non-programmable thermostat.** 1 stage heat, 1 stage cool. Fan switch: Auto & On. Manual changeover system switch: Cool-Off-Heat. Low temperature protection. °F or °C selectable. Thirty minute power loss memory retention. For use with models VAIA only. Marvair P/N 50121.
- Digital, seven day programmable thermostat.** 1 stage heat, 1 stage cool. Fan switch: Auto & On. Auto changeover. Keypad lockout. Non-volatile program memory. Title 24 compliant. For use with models VAIA only. Marvair P/N 50123.
- Digital, non-programmable thermostat.** One stage cool/One stage heat. Manual or auto changeover. Fan mode: Auto or On. Permanent retention of settings upon power loss. Field adjustable temperature calibration. Max heat and minimum cool set points. Adjustable temperature differential. Remote sensor capable. Keypad lock out. Status LED. °F or °C selectable. For use with models VAIA only. Marvair P/N 50186.

#### **C. Humidity Controller.**

All units with Electric reheat or Hot Gas Reheat must have a method of signaling the reheat function. If a DDC system is not being used, a Humidity Controller must be installed.

- **Defrost Timer (heat pumps only)** - Adjustable defrost control that is based upon both time and temperature. The preset time interval is adjustable from 30, 60 or 90 minutes using the HMI screen on the PLC.
- **BAS Control Relay** - Provides 24 VAC coil to control operation from Building Automation System (BAS). Note - an additional BAS control relay can be added when 120 or 240 VAC coils are required.

### **IMPORTANT**

**MINIMUM AIR FLOW IS REQUIRED FOR PROPER OPERATION.**

## **1.5 OPTIONAL CONTROLS**

### **A. All Units Have the Following Control Options Available:**

- Hard Start Kit** - Field installed and used on single phase power models to overcome hard starting conditions.
- Motorized Fresh Air Damper with Powervent Ventilation** - Equipped with a **fresh air fan speed control**. The fresh air fan speed control controls the ventilation intake blower, automatically balancing the intake and exhaust cfm up to 450 cfm.

## Chapter 2: Scholar QR Installation

### 2.1 TOOLS/FIELD FURNISHED SUPPLIES

#### WARNING

**TO AVOID PERSONAL INJURY, ADEQUATE PROTECTIVE CLOTHING MUST BE WORN AND PRECAUTIONS IN HANDLING AND INSTALLING THIS EQUIPMENT MUST BE PRACTICED AT ALL TIMES.**

- Power Drill/Driver & Extension
- T25 TORX Bits
- 5/16 hex bit
- Needle Nose Pliers
- Wire Stripper/Cutter
- Spirit Level
- Tape Measure
- Screwdriver with Slotted Bit
- Caulk Gun
- Sealant Caulk (tube)
- Wire Nuts for Power and Control Wiring Gauges
- Supplies to Install PVC Condensate Drain
- Floor Fasteners for Cabinet (4 required for 1/2" pass through holes) - Appropriate Drivers for Floor Fasteners
- Supplies to Install Wet Heat Coil (Steam or Hot Water) (if appropriate)
- 25 Ft. of Polyurethane Foam Strips, 1" Wide x 1/2" Thick, Adhesive Backing, for Scholar/Wall Interface.
- Genie Lift, or equivalent

### 2.2 INSPECTION/UNPACKING/HANDLING

A. The Scholar QR series of heat pumps and air conditioners are shipped to the job site on 4x4 wood base framing, and enclosed in shrink wrap.

Freeblow and ducted plenums are shipped on wooden skids and enclosed in shrink wrap.

Outdoor louvers/collar assemblies, louvers and collars are shipped in corrugated containers.

Base stands are shipped on a wooden skid and are enclosed in shrink wrap.

Trim pieces are enclosed in corrugated carton and strapped to a wooden skid.

**B. Immediately upon delivery to the jobsite, each Scholar QR heat pump or air conditioner and the appropriate additional accessories should be inspected for visible and concealed damage. All damage must be reported to the freight carrier within 15 days, on the freight carrier's form.**

The Scholar QR heat pump or air conditioner and additional accessories should be stored inside and not exposed to outdoor weather conditions. Do not remove equipment from packing until it is ready to be installed.

 **WARNING**

**DO NOT STACK THE UNIT OR ANY ACCESSORIES ON TOP OF ONE ANOTHER. THE UNITS SHOULD ALWAYS REMAIN IN THE UPRIGHT POSITION WHEN BEING SHIPPED, STORED, HANDLED OR INSTALLED.**

**DO NOT STORE THE UNIT OR ACCESSORIES IN OUTDOOR WEATHER CONDITIONS.**

 **WARNING**

**THE SCHOLAR QR UNIT WEIGHS IN EXCESS OF 1,000 LBS. WHEN MOVING THE UNIT, SUFFICIENT MANPOWER AND MECHANICAL EQUIPMENT MUST BE USED TO PREVENT DAMAGE TO THE UNIT AND INJURY TO PEOPLE. TO FACILITATE MOVING THE SCHOLAR QR, IT WILL BE NECESSARY TO ACCESS THE FORKLIFT AISLES AS SHOWN ON PAGE 20. THE UNIT SHOULD NOT BE PLACED ON ITS SIDE. IF THE SCHOLAR QR HAS BEEN PLACED ON ITS SIDE, THIS WILL VOID WARRANTY.**

C. Note the unit identification label is located on the right side cabinet panel at the lower front corner. The identification label has the model and serial number on it and the type of refrigerant and amount of refrigerant charge.

**IMPORTANT**

**WHEN THE HEAT PUMP OR AIR CONDITIONER IS INSTALLED, MODEL NUMBER AND SERIAL NUMBERS ARE TO BE RECORDED ON THE COVER OF THIS MANUAL AND MAINTAINED IN A LOCATION FOR IMMEDIATE ACCESS, WHEN REQUESTING FURTHER INFORMATION CONCERNING THIS EQUIPMENT.**

## 2.3 PRE CHECKS

Where electrical components are being changed, they shall be fit for the purpose and to the correct specification. At all times the manufacturer's maintenance and service guidelines shall be followed. If in doubt, consult the manufacturer's technical department for assistance.

The following checks shall be applied to installations using FLAMMABLE REFRIGERANTS:

1. The actual REFRIGERANT CHARGE is in accordance with the room size within which the refrigerant containing parts are installed.
2. The ventilation machinery and outlets are operating adequately and are not obstructed.
3. If an indirect refrigerating circuit is being used, the secondary circuit shall be checked for the presence of refrigerant.
4. Marking to the equipment continues to be visible and legible. Markings and signs that are illegible shall be corrected.
5. Refrigerating pipe or components are installed in a position where they are unlikely to be exposed to any substance which may corrode refrigerant containing components, unless the components are constructed of materials which are inherently resistant to being corroded or are suitably protected against being so corroded.
6. Check that cabling will not be subject to wear, corrosion, excessive pressure, vibration, sharp edges or any other adverse environmental effects. The check shall also take into account the effects of aging or continual vibration from sources such as compressors or fans.

## 2.4 LOCATION SELECTION AND PREPARATION



**WARNING**

**THE SCHOLAR QR HEAT PUMP AND AIR CONDITIONER MUST BE INSTALLED IN CONFORMANCE WITH ALL APPLICABLE LOCAL AND NATIONAL ELECTRICAL, PLUMBING AND BUILDING CODES.**

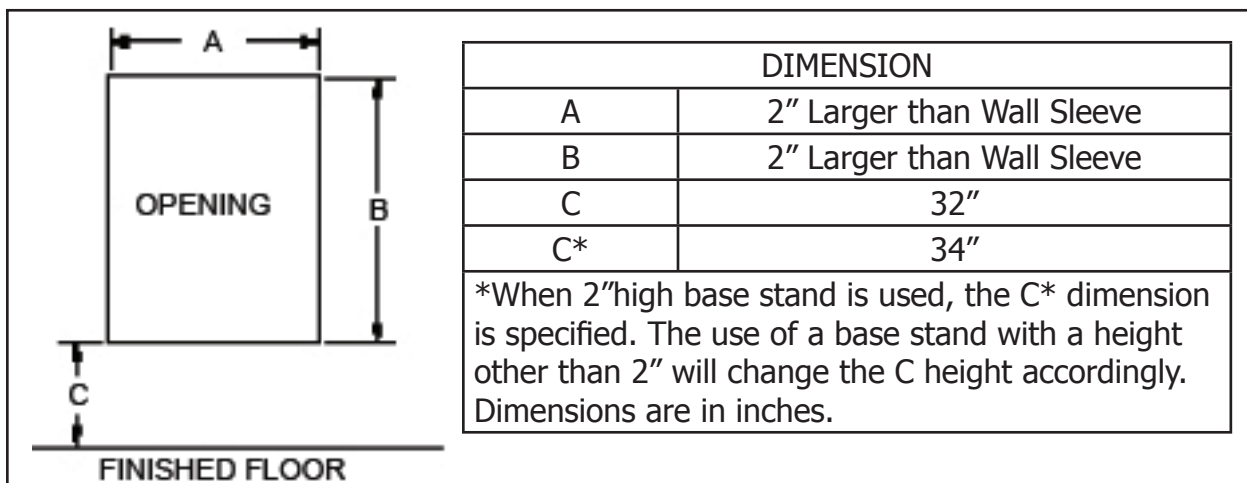
A. The Scholar QR heat pump and air conditioner must be installed on an outside wall for access to outside air. The wall opening dimensions are shown in Figure 2. It must not interfere with any windows or doors to the outside. The outdoor air path must not be impeded by shrubbery or other obstructions. Do not locate the Scholar QR heat pump or air conditioner where noxious fumes or gas can be drawn in from the outdoor air and introduced in the classroom.

The Scholar QR heat pump or air conditioner must be installed on a hard, level, smooth surface such as concrete, wood or tile. Do not install the unit on a carpeted surface. Do not locate the either side of the Scholar within 12" from a wall. The front doors swing open to allow access to all components. Do not put anything immovable in front of the Scholar QR unit.

To remove carpet from where the "footprint" of the unit will be, when installed, carefully measure, cut and remove carpet from an area based on the dimensions of the Scholar QR cabinet as described in Figure 3; and allowing for any offset or standoff from the finished interior surface of the wall.

Prior to installation of the Scholar QR heat pump or air conditioner, provisions are to be made for the following, as appropriate.

1. Wall opening dimensions for the Scholar QR heat pump and air conditioner are as shown in Figure 2. The unit is designed for installation through a 14 inch thickness finished wall. For finished wall depth less than 14 inches, the unit will stand off from the interior finished wall and it will be necessary to order and install trim pieces to provide a finished, color coordinated enclosure that fits flush to the interior wall.



**Figure 4. Wall Opening Dimensions for Scholar QR Heat Pump and Air Conditioner**

Scholar Heat Pumps	VAH2030H	VDH2036H	VDH2040H	VAH2048H
Minimum Room Size (ft <sup>2</sup> )	166.9	196.4	196.4	206.2
Minimum Supply Height (ft)	6.9	6.9	6.9	6.9

Scholar Air Conditioners	VAH2030A	VDH2036A	VDH2040A	VAH2048A
Minimum Room Size (ft <sup>2</sup> )	166.9	196.4	196.4	206.2
Minimum Supply Height (ft)	6.9	6.9	6.9	6.9

**Table 1. Room Size Limitations**

Altitude (Meters)	Altitude (Feet)	Correction Factor
0	0	1.0
200	660	1.0
400	1310	1.0
600	1970	1.0
800	2620	1.0
1000	3280	1.1
1200	3940	1.1
1400	4590	1.1
1600	5250	1.1
1800	5910	1.2
2000	6560	1.2
2200	7220	1.2
2400	7870	1.3
2600	8530	1.3
2800	9190	1.3
3000	9840	1.4
3200	10500	1.4
3400	11150	1.5
3600	11810	1.5
3800	12470	1.6
4000	13120	1.6
4200	13780	1.7
4400	14440	1.7
4600	15090	1.8
4800	15750	1.9
5000	16400	1.9

In accordance with UL 60335-2-40, for units above 600m, multiply the minimum room area stated in the table above by the correction factor that corresponds with the altitude the unit is located at. This will give you a new minimum room area that is adjusted for your altitude. The units listed in this manual are not intended for use above 5000 meters.

**Table 2. Altitude Correction Factor**

## 2.5 POWER AND CONTROL WIRING (ROUGH-IN)

### CAUTION

**NOTICE TO INSTALLER/CONTRACTORS: THIS UNIT'S INTERNAL CONTROL CIRCUIT/ TRANSFORMER IS DESIGNED TO POWER FACTORY INSTALLED UNIT COMPONENTS ONLY. CONNECTING EXTERNAL COMPONENT LOADS MAY BE DONE AT YOUR OWN RISK OF VOIDING THE MANUFACTURER'S PRODUCT WARRANTY.**

Line voltage power supply must be sized to provide adequate power for the operation of the specific model heat pump and, if chosen, the electric heat option. Information on line power requirements, line sizing and fuse sizing is shown on data label on unit. The power leads can enter the heat pump or air conditioner either through the bottom or rear. The locations of the knockouts for power leads are shown in Figure 3. Depending on the location of the Scholar

QR heat pump or air conditioner relative to the outside wall, the exact rough-in location for power lines in the school room can be determined. Six feet of power line should be available inside the cabinet for routing and connecting the power lines, after the Scholar QR unit is installed. If entry is from bottom, the stub-out should be no higher than 1/2" from the classroom floor to allow the unit to slide into the wall opening.

### **IMPORTANT**

**IF "S CIRCUIT" POSITION IS SELECTED ON THE ELECTRIC HEAT CONTROL (SEE ARTICLE 1.11), LOWER MINIMUM CIRCUIT AMPACITY MAY BE PERMITTED.**

B. Low voltage wiring can be roughed in to either the back (outside wall) or bottom (floor) of the cabinet. Six feet of low voltage wire should be available for routing and termination within the unit. If the entry is from the bottom, the stub-out should be no higher than 1/2" from the classroom floor to allow the Scholar QR heat pump and air conditioner to slide into the wall opening. Reference Figure 3 as noted above, for control wiring entry points into the cabinet.

## **2.6 CONDENSATE DRAIN LINE (ROUGH-IN)**

A. The condensate drain line can be roughed in to drain the Scholar QR heat pump or air conditioner from the bottom (floor) or rear. The locations for the condensate stub-outs can be determined from the cabinet openings identified in Figure 3. The factory installed condensate connection within the cabinet is a female PVC fitting designed for a 3/4" slip connection.

### **⚠ CAUTION**

**INSPECT THE FLEXIBLE CONDENSATE DRAIN LINE INSIDE THE SCHOLAR QR UNIT (WHEN INSTALLED) FOR POSSIBLE TUBING COLLAPSE. CORRECT AS APPROPRIATE.**

## **2.7 WET HEAT (ROUGH-IN)**

A. Hot water coil connections are made by dropping supply and return lines through the knockout locations in the top of the plenums, as described in Figure 3 for the heat pump. Access to the interior cabinet is through these factory-notched locations.

## **2.8 PREPARATION OF THE SCHOLAR QR HEAT PUMP AND AIR CONDITIONER**

### **⚠ WARNING**

**TO AVOID PERSONAL INJURY, ADEQUATE PROTECTIVE CLOTHING MUST BE WORN AND PRECAUTIONS IN HANDLING AND INSTALLING THIS EQUIPMENT MUST BE PRACTICED AT ALL TIMES.**

After the rough-in is complete, the Scholar QR heat pump or air conditioner and accessories must be prepared for final installation prior to start-up. The following items are to be completed prior to final installation.

- A. Remove the two shipping screws that are at the top and bottom of the front door.
- B. Open the front door for access to the lag bolts that hold the shipping skids in place. Unscrew the 4 lag screws. Note: access to the back right lag screw is easier through the the condensate opening in the back panel beneath the outdoor air box. Remove the shipping skids.



- C. To facilitate moving the Scholar through doors, the out door air box can be removed. To remove the outdoor air box, remove the 16 screws - 6 on each side and 4 along the top. Remember to reinstall the outdoor air box before placing the Scholar into its final position in the classroom.
- D. If the base stand accessory was chosen, install the base stand in accordance with installation instructions included with the base stand or see Appendix B at end of manual.
- E. Hot Water Plenum. The protective film on top of the Scholar QR cabinet and on the plenum must be removed to install the plenum. Fasten the plenum to the top of the cabinet in accordance with the instructions included with the plenum or Appendix C at end of manual.
- F. Freeblow Plenum/Ducted Plenum. All Scholar QR heat pump and air conditioners use an electronically commutated (EC) blower motor to distribute the conditioned air throughout the classroom. The EC motor automatically adjusts its speed to maintain the proper air flow over a wide variety of external static pressures in an air distribution system. If only the freeblow plenum is used (no external duct work), the blower automatically slows down. When duct is used, the EC blower automatically speeds up to compensate for the additional static pressure. The blower automatically slows down when in the ventilation mode (compressor off) to deliver the required cfm of fresh air to the classroom. No field adjustment of the blower is required. Install plenum to top of cabinet after shipping plate has been removed from electric heater (if appropriate). Instructions are included with plenum or see Appendix C at end of manual.
- The air distribution system which is field supplied and installed downstream of the specified **ducted plenum** must be engineered to assure sufficient air flow, even under adverse conditions, such as dirty filters. The information provided in Figure 1, Appendix A should be used to design the air distribution system duct size leaving the Scholar QR heat pump or air conditioner, keeping the external static pressure to a minimum.
- Applications using duct work should be designed and installed in accordance with the current edition of the National Fire Protection Association codes and standards 90A and 90B. The duct system must be engineered to insure sufficient air flow through the unit to prevent over-heating of the heater element. This includes proper supply duct sizing, sufficient quantity of supply registers, adequate return and filter area. Ductwork must be of correct material and must be properly insulated. The duct work must be constructed of galvanized steel with a minimum thickness of .019. Ductwork must be firmly attached, secured and sealed to prevent air leakage. Do not use duct liner on inside of supply duct within four feet of the unit.
- Galvanized metal duct extensions should be used to simplify connections to ductwork and grilles. Use fabric boots to prevent the transmission of vibration through the duct system. The fabric must be U.L. rated to a minimum of 197°F.
- G. Install the outdoor louver/collar assembly to the outdoor side of the wall opening. The louver/collar assembly may be fastened to the air box (or air box extension) as described in the instructions for outdoor louvers/collars. The louver must be installed with the blades pointing downward on the outside and the louver and the collar must be water sealed to the outside wall surface with the appropriate caulking material. See the instructions that come with the outdoor louver for installation details or see Appendix F at the end of this manual.
- H. Weather Panels are field supplied and do not come with the Scholar QR heat pump or air conditioner. If a weather panel covers the wall opening described in Figure 2, remove the weather panel prior to installing the unit into the wall opening.

- I. After measuring for correct locations of power/control wiring entry, condensate drain line, and the appropriate wet heat lines, remove the appropriate knock-out access ports from the cabinet. Be sure they align with the rough-in points for the noted pipes and wires. Be sure electrical, condensate and wet heat piping will not cause interference or be damaged by sliding the Scholar QR heat pump or air conditioner into place.

### **IMPORTANT**

**BE SURE TO SEAL THE OPEN AREAS BETWEEN LINES ENTERING THE SCHOLAR QR CABINET AND THE KNOCKOUT OPENINGS, TO PREVENT AIR LEAKAGE.**

- J. If the heat pump or air conditioner is to fit flush against the inside of the exterior wall, cut to length, strips of open cell polyurethane foam 1" wide by 1/2" thick with adhesive backing, field supplied, on one side. This may be applied to the back of the heat pump and plenum along and flush with the two vertical and top horizontal edges. These strips will provide a finished appearance to the wall/heat pump interface and provide a seal between the equipment and wall. If the heat pump or air conditioner is applied with a side against a wall (in a corner), use the same strip material on the end panel along the side vertical edge.
- K. Prior to sliding the Scholar QR heat pump or air conditioner into the wall opening, check to be sure that the floor surface is hard, smooth and level (concrete, wood, vinyl tile or the equivalent). If the floor is carpeted, cut out an appropriate "footprint" based on the Figure 3 drawings and the location of the unit relative to the inside finished wall (flush or offset). Be sure the surface is level or provisions are made to level the unit upon installation.
- L. If the outdoor air box was removed, reinstall it prior before placing the Scholar QR unit in its final position. Install the outdoor air box onto the back of the Scholar™ III heat pumps or air conditioners before sliding the unit into position. Apply a weather-proof sealant; i.e., silicone, onto the back of the Scholar QR heat pump or air conditioner prior to installing the outdoor air box to prevent water leaks.

## 2.9 PREPARING SCHOLAR QR FOR INSTALLATION

### IMPORTANT

THIS UNIT CONTAINS BALL-TYPE SHUT-OFF VALVES IN THE SUCTION LINE AND DISCHARGE LINE AT THE COMPRESSOR.

THE VALVES ARE SHIPPED FROM THE FACTORY IN THE CLOSED POSITION.



THE VALVES MUST REMAIN CLOSED UNTIL THE UNIT IS INSTALLED IN ITS PERMANENT UPRIGHT POSITION.

POWER MUST BE ON FOR AT LEAST 24 HOURS PRIOR TO OPERATING THE COMPRESSOR TO ALLOW PRE-HEATING FROM THE COMPRESSOR CRANKCASE HEATER. THE VALVES MUST BE OPENED AT THE SAME TIME THE CRANKCASE HEATER IS ENERGIZED FOR LIQUID REFRIGERANT TO BE EVAPORATED AND DRIVEN FROM THE COMPRESSOR CRANKCASE.

THE VALVES MUST BE OPENED PRIOR TO FULL OPERATION.

DO NOT OPERATE THE COMPRESSOR WITH THESE VALVES CLOSED. THIS WILL VOID THE FACTORY WARRANTY.

REFER TO THE WARNING LABEL ON THE COMPRESSOR PLUG. THE COMPRESSOR WILL NOT RUN WITHOUT CONNECTING THE PLUG.

### ⚠ WARNING

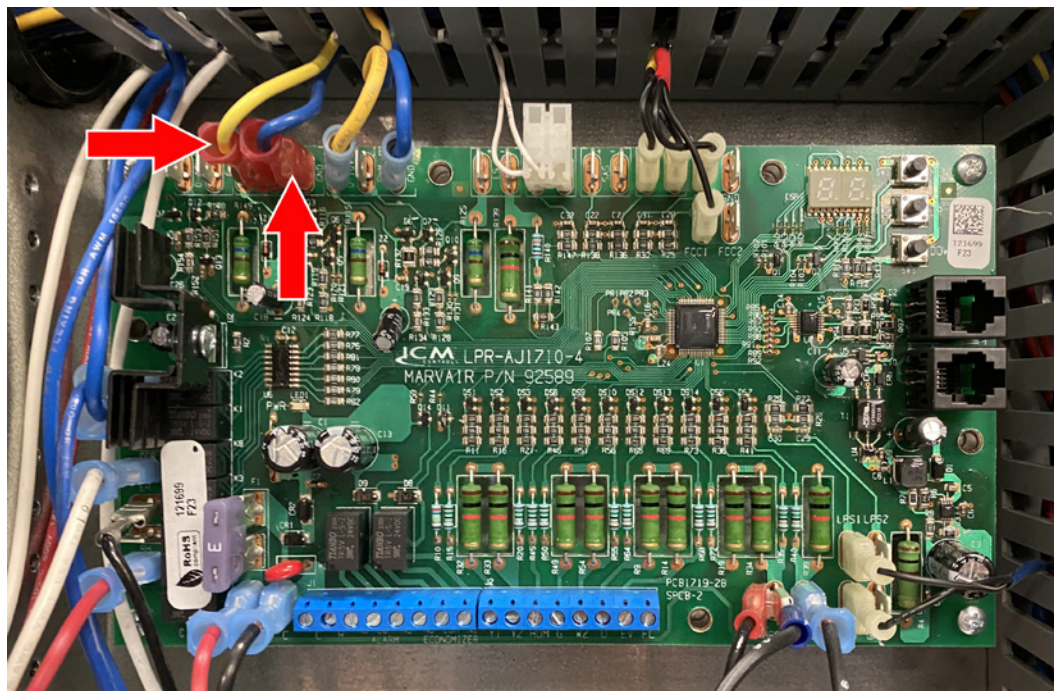
THE SCHOLAR QR UNIT WEIGHS IN EXCESS OF 1,000 LBS. WHEN MOVING THE UNIT, SUFFICIENT MANPOWER AND MECHANICAL EQUIPMENT MUST BE USED TO PREVENT DAMAGE TO THE UNIT AND INJURY TO PEOPLE. TO FACILITATE MOVING THE SCHOLAR QR, IT MAY BE NECESSARY TO PLACE THE UNIT ON ITS SIDE. IF THE SCHOLAR QR IS PLACED ON ITS SIDE, IT MUST BE THE RIGHTHAND SIDE ONLY. PLACING THE UNIT ON ITS LEFTHAND SIDE WILL VOID WARRANTY.

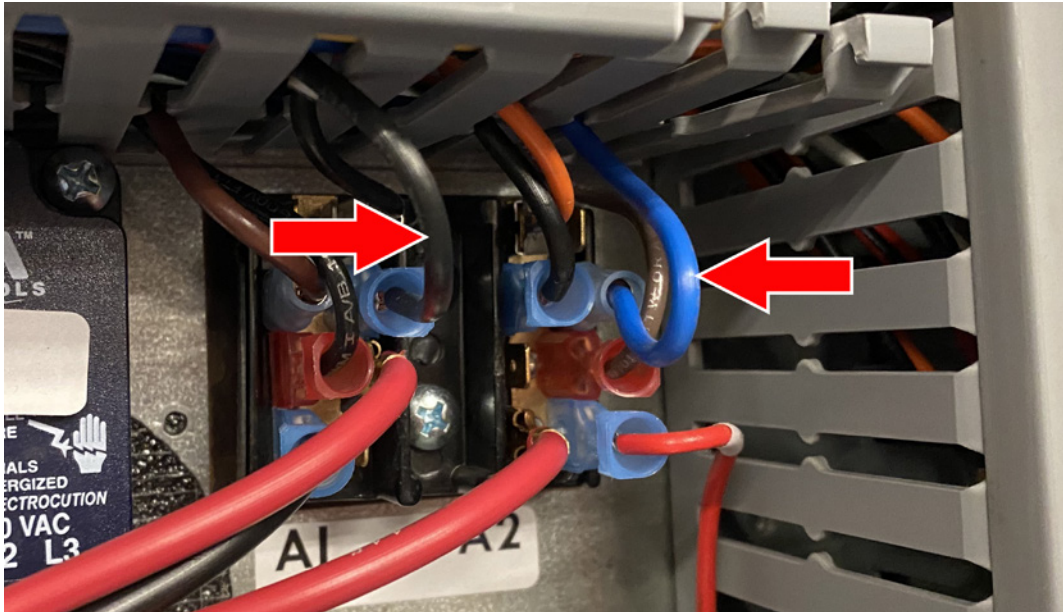


- A. With the Scholar QR unit upright, turn the two quarter turn locks on the front door to the open position and swing the front doors open.
- B. The doors are on removable hinges. To remove each door, tap out the hinge pins and then lift the door off the hinges and place the doors safely out of the way.

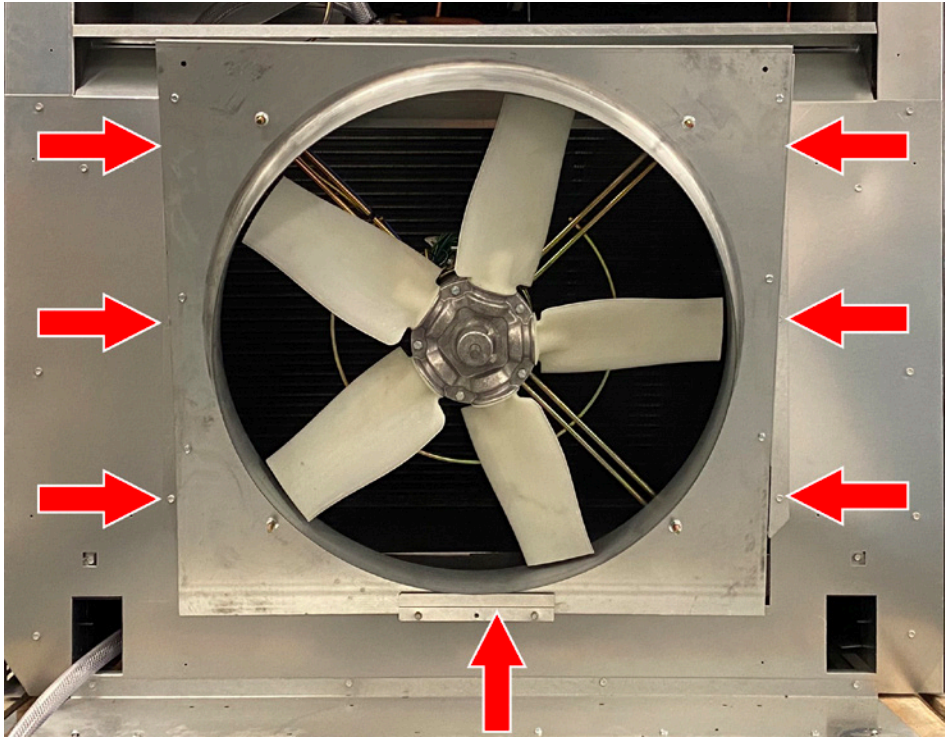


- C. Confirm Ball Valves are **closed**.
- D. In order to fit through a doorway, the condenser fan may have to be removed and the Scholar QR unit laid on its right side only.
- E. Locate and disconnect the 4 wires to the condenser fan motor within the electrical controls panel.





F. Remove the six (6) screws securing the fan assembly to the cabinet, then lift the assembly out of the bottom bracket.



G. Lay the Scholar unit on its right side.



H. Once in position, stand the Scholar QR back up, reinstall the condenser fan assembly and reconnect the 4 wires in the electrical controls panel.

I. ***Open*** the ball valves and connect the compressor electrical connector.

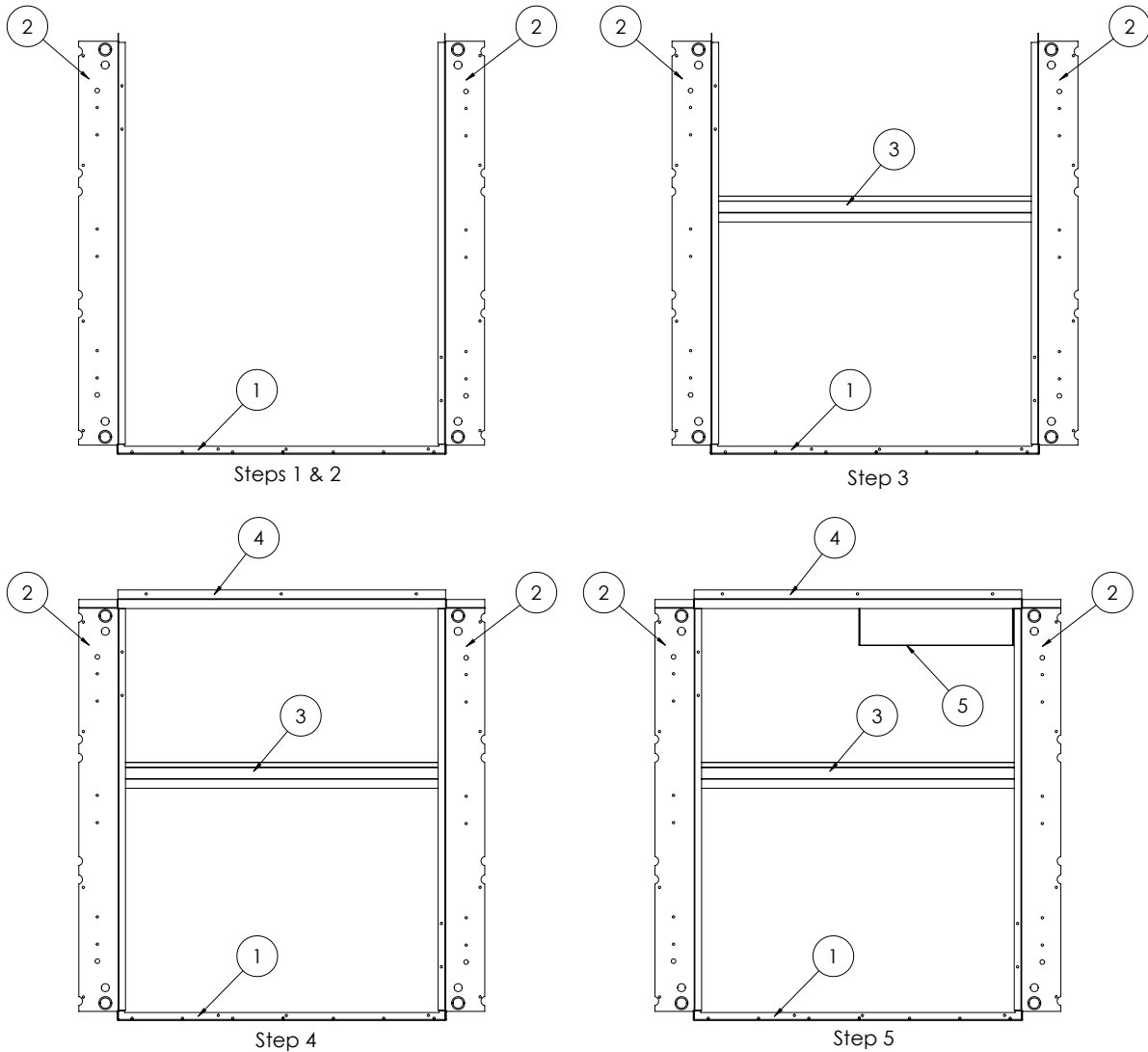
J. Reinstall the front doors.

### IMPORTANT

**POWER MUST BE ON FOR AT LEAST 24 HOURS PRIOR TO OPERATING THE COMPRESSOR TO ALLOW PRE-HEATING FROM THE COMPRESSOR CRANKCASE HEATER. THE BALL VALVES MUST BE OPENED AT THE SAME TIME THE CRANKCASE HEATER IS ENERGIZED FOR LIQUID REFRIGERANT TO BE EVAPORATED AND DRIVEN FROM THE COMPRESSOR CRANKCASE.**

## 2.10 WALL SLEEVE FIELD ASSEMBLY STEPS

1. Place the bottom of the wall sleeve (#1) on the ground with flanges pointed up.
2. Attach both of the sides of the wall sleeve (#2) to the bottom pan. Make sure flanges are facing outwards.
3. Attach the horizontal divider (#3) to the two sides (#2).
4. Attach the top panel (#4) to the two sides (#2).
5. Attach the Fresh air intake divider (#5) to the top panel (#4).



Item #	Part #	Description	Qty
1	SMV15013X	36" SNOOT BOTTOM	1
2	SMV15016X	CENTER SNOOT SIDES	2
3	SMV15042X	HORIZONTAL DIVIDER	1
4	SMV15054X	C CABINET WALL SLEEVE TOP - 35"	1
5	SMV15045X	FRESH AIR DIVIDER, SNOOT	1

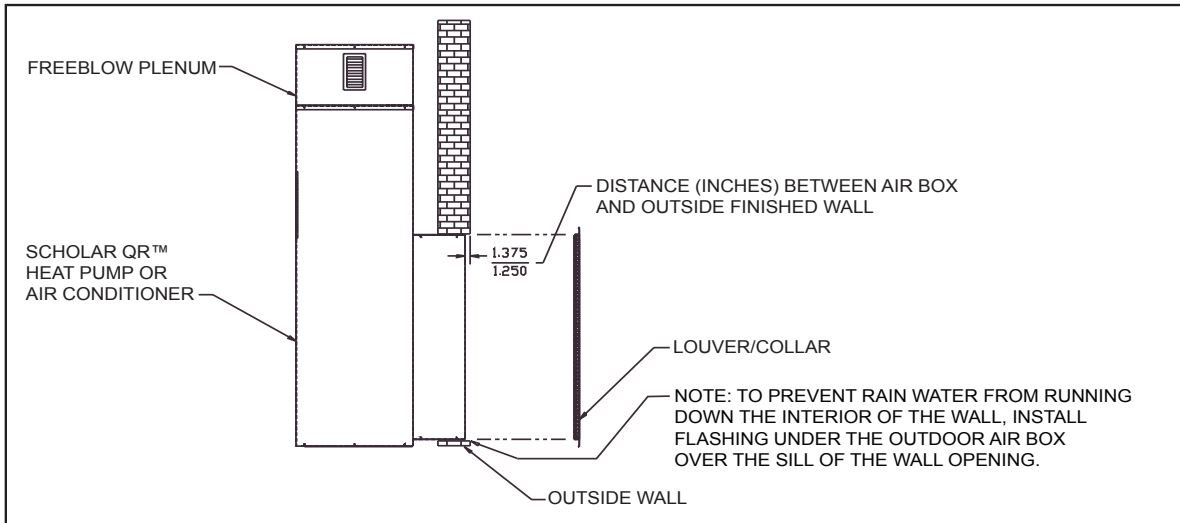
## 2.11 INSTALLATION THROUGH THE OUTSIDE WALL

- A. Slide the Scholar QR heat pump or air conditioner into the wall opening slowly,

being careful to clear the appropriate stubouts. The heat pump or air conditioner, when installed properly, should have a clearance between the air box outside edge and the finished outside wall as shown in Figure 4. Proper fit up of the louver/collar assembly to the air box to the outside wall requires the noted recess dimension to be maintained after installing the unit.

B. To minimize sound in the classroom, insulate all four sides of the outdoor air box that is internal to the classroom with the following:

- Layer 1: 1/2" Rubatex
- Layer 2: 1-1/2" Duct Board



**Figure 5. Dimension Between Scholar QR Heat Pump or Air Conditioner Air Box and Finished Outside Wall for Outdoor Louver/Collar Assembly Installation**

**CAUTION**

**WHEN FASTENING LOUVER/COLLAR ASSEMBLY TO AIR BOX, DO NOT OVERTIGHTEN LOUVER SCREWS. OVERTIGHTENING SCREWS WILL CAUSE DAMAGE AND WARP THE LOUVER/COLLAR ASSEMBLY. TO PREVENT WATER FROM RUNNING DOWN THE INTERIOR OF THE WALL, INSTALL FLASHING UNDER THE OUTDOOR AIR BOX, OVER THE SILL OF THE WALL.**

- C. Check (with a spirit level) to see that the heat pump or air conditioner is level and plumb. If it is not, take the appropriate corrective action to level and plumb the system. 1/8" thick washers with 1/2" pass through holes can be installed appropriately under the fastener holes in the base of the heat pump or air conditioner to make the system level and plumb.
- D. Secure the heat pump or air conditioner to the floor with appropriate field supplied fasteners, through the four 1/2" diameter through holes in the base.
- E. If the Scholar QR heat pump or air conditioner is offset from the outside wall, trim strips should be installed at this time. Check instructions that come with trim strips for installation or see Appendix D at end of this manual.
- F. If appropriate, install wall brackets to the inside surface of the outside wall and to the cabinet of the Scholar QR unit, at this time. Check instructions with wall brackets for installation or see Appendix E at end of this manual.



## 2.12 CONDENSATE FLOAT SWITCH FUNCTIONAL CHECK

A float switch comes standard in all Scholar HVAC units. It is used to manage condensation in both the evaporator and the condenser drain pans. In normal operation, the float switch is closed. In the event condensation levels in drain pan become too high, the float switch opens to terminate the heating, cooling or dehumidification process.

After installation of the HVAC unit, a functional check is required to verify that the operation of the float switch was not compromised in transit or installation. “

### STEPS TO TEST FLOAT SWITCH:

- A. Turn off the Scholar system: Before testing the float switch, turn off the heating or cooling system to prevent any potential electrical shock or damage to the system.
- B. Locate the float switch. The float switch is located in the drip pan of the Scholar unit.
- C. Inspect the float switch. Check the float switch for any visible damage or defects and ensure that it is clean and free of any debris or build-up.
- D. Test the switch manually: Gently lift the float switch to simulate the rise in water level in the drip pan. Use a multimeter to check the continuity of the wires leading to and from the float switch. There should be no continuity while the switch is lifted.
- E. Release the switch. Use multimeter to check continuity again. There should be continuity when the float switch is in this position.

It is always recommended to have a professional HVAC technician test or inspect the float switch functionality.

## 2.13 ELECTRICAL, CONDENSATE AND WET HEAT HOOK-UPS

### WARNING

**ALL ELECTRICAL, PLUMBING, AND REFRIGERATION WORK MUST MEET THE REQUIREMENTS OF LOCAL AND NATIONAL CODES AND ORDINANCES. WORK SHOULD BE DONE ONLY BY PROFESSIONALLY QUALIFIED AND TRAINED SERVICE PEOPLE.**

### IMPORTANT

**STUBOUTS SHOULD BE LOCATED (FROM THE FLOOR) TO BE DIRECTLY OPPOSITE THE SELECTED CABINET KNOCKOUT ON THE CABINET, AS SHOWN IN FIGURE 3. THIS IS A REQUIREMENT IF A BASE STAND IS TO BE INSTALLED AND STUBOUTS ARE COMING THROUGH THE FLOOR.**

- A. For line voltage wiring, the power supply must have the correct voltage, phase and ampacity for the selected Scholar QR unit. Check the data label on each Scholar QR unit to determine these values.
- B. Be sure that the power to the line voltage wiring is off prior to hooking-up the wiring within the Scholar QR cabinet. Remove the lower front panel for access to the disconnect. Figure 5 illustrates the disconnect location with the lower front panel removed. Turn the disconnect to “OFF” position.

- C. The electrical control compartment is located behind the front door at the lower right hand corner of the unit. The electrical schematic for the heat pump or air conditioner is contained in a pocket on the inside of the middle front panel door. Figure 6 shows typical control centers for the Scholar QR heat pump and air conditioner. Figures 7 and 8 show typical single and three phase wiring diagrams for the Scholar QR heat pump and air conditioner.
- D. Power supply service must be with the allowable voltage range stamped on the identification plate. To operate a nominal 230/208V model on 208V, change the transformer line tap from 240V to 208V, following the instructions on the electrical schematic.
- E. Connect the main power wires coming into the cabinet to the input side of the disconnect. (L1 and L2 for single phase units and L1, L2 and L3 for three phase models.) Install the ground wire on the ground lug.

 **CAUTION**

**THIS SYSTEM CONTAINS COMPONENTS THAT REQUIRE PHASING FOR CORRECT ROTATION. FAILURE TO OBSERVE ROTATION AND CORRECT ON START-UP WILL CAUSE DAMAGE NOT COVERED BY THE MARVAIR® WARRANTY.**

Scroll compressors, like several other types of compressors, will only compress in one rotational direction. The direction of rotation is not an issue with single-phase compressors since they will always start and run in the proper direction. However, three phase compressors will rotate in either direction depending upon phasing of power. Since there is a 50-50 chance of connecting power in such a way as to cause rotation in the reverse direction, it is imperative to confirm that the compressor is rotating in the proper direction at the initial field start-up of the system. Verification of proper rotation is made by observing that the suction pressure drops and the discharge pressure rises when the compressor is energized. An alternate method of verification for self contained system with small critical refrigerant charges, where the installation of gauges may be objectionable, can be made by monitoring the temperature of the refrigerant lines at the compressor. The temperature should rise on the discharge line while the suction line temperature decreases. Reverse rotation also results in a substantially reduced current draw when compared to tabulated values.

There is no negative impact on durability caused by operating three phase compressors in the reversed direction for a short duration of time, usually defined as less than one hour. However, after several minutes of operation the compressor's internal protector will trip. The compressor will then cycle on the protector until the phasing is corrected. Reverse operation for longer than one hour may have a negative impact on the bearings.

A. Low voltage wiring must be Class 1.

1. For Scholar QR units with a remote (wall mounted) thermostat, route the low voltage wiring from the point of entry into the cabinet, upward through the raceway adjacent to the disconnect shown in Figure 5.
2. Route wires into the terminal strip compartment through the openings provided. Connect wiring to the terminal strip as shown in Figure 9 for a remote, wall mounted thermostat installation.

## 2.14 REMOTE THERMOSTAT INSTALLATION

A. Locate the thermostat about five feet above the floor on an inside wall. Avoid the following:

### Hot Spots

Concealed Pipes or Duct  
Registers  
TV Sets  
Radio  
Lamps  
Direct Sunlight

### Cold Spots

Concealed Pipe or Ducts  
Stairwells - Drafts  
Doors - Drafts  
Unheated Rooms on Other  
Side of Wall

### Dead Spots

Behind Doors  
Corners and Alcoves

After choosing the wall upon which to mount the thermostat, see instructions in the thermostat box for mounting the thermostat on the wall.

B. The thermostat should be wired to the terminal strip in the Scholar QR heat pump or air conditioner in accordance with the connection diagram, and in accordance with the thermostat instructions, National Electric Code, and with local electrical codes, where they prevail.

THERMOSTAT  
PART NUMBER

50121/  
SC2010-SL



50122/  
SC2210-SL



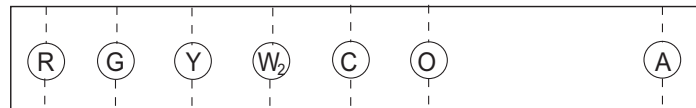
50252/  
SC4811-SL



50107/  
SC5811-SL

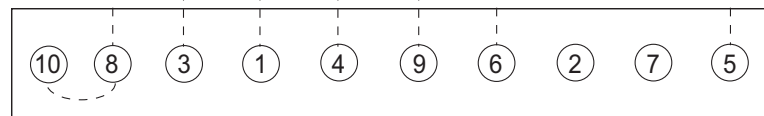


CLASSIC I &  
SCHOLAR  
W/O REHEAT



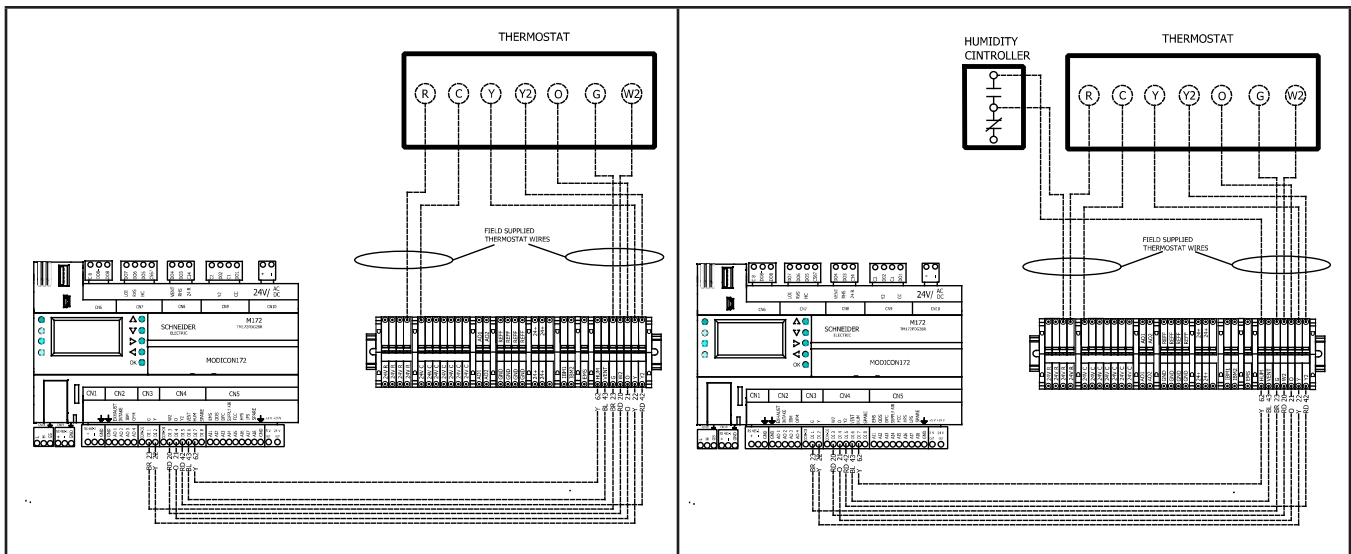
LOW VOLTAGE  
TERMINAL BOARD

CLASSIC II  
WITH  
ECONOMIZER  
& W/O REHEAT



LOW VOLTAGE  
TERMINAL BOARD

POWER  
FAN  
COMPRESSOR  
AUX. HEAT  
COMMON  
REVERSING  
VALVE  
LOCK-OUT  
LOCK-OUT



**Figure 6a. Remote Wall Mounted Thermostat Wiring Detail**

**Figure 6b. Remote Thermostat w/Humidity Controller Wiring Detail**

- C. For Scholar QR heat pump or air conditioner that interfaces with a building automation system (BAS) or energy management system (EMS), detailed instructions for the specific system being installed will be supplied separately by the manufacturer of the BAS/EMS system.

The control of the GreenCube ERV and Ventilation relay (VR) are 24 volt inputs to the PLC. If 120 V. of 240 inputs are required, additional relays must be installed in the factory or in the field. The EMS is tied to the float switch and will shut the system down if the switch is closed (indicating the drain pan water reached its limit). For end user control of the EMS, refer to Figure 7.

For immediate shut down of unit, provide a normally open contact and connect on parallel with float switch.

The unit control system is factory wired to operate upon an input signal from any appropriate 24 VAC control thermostat or DDC control system.

The unit control system is factory wired to energize the ventilation package. If additional control of the ventilation package is desired, it may be accomplished by the following: The Controls Contractor must remove the factory installed jumper between terminals Vent and 24V R then provide a set of contacts (24 VAC pilot duty) between terminals Vent and 24V R. When the field supplied contacts between Vent and 24 V R are closed the ventilation package will operate and energize the blower. See Figure 10. Alternatively, you may disconnect the GWR jumper and provide 24V to the Vent input.

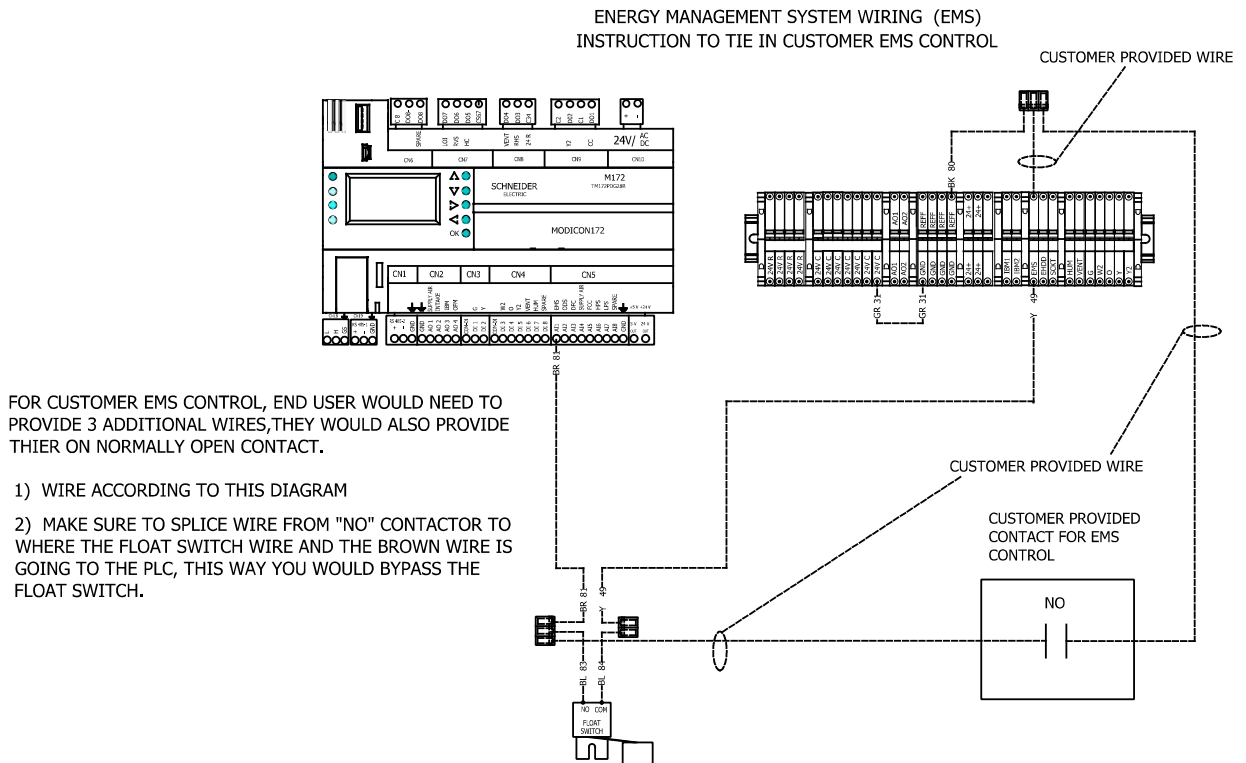
Ventilation can be tied into a scheduling system to turn the ventilation off during unoccupied times and and back on during occupied times.

This would still keep the float switch in the system to shutdown the unit if water in the drain pan gets too high and also provide emergency shutdown from customer system.

The Exhaust fan motor speed can be adjusted on the PLC “Fresh Air Motor” screen.

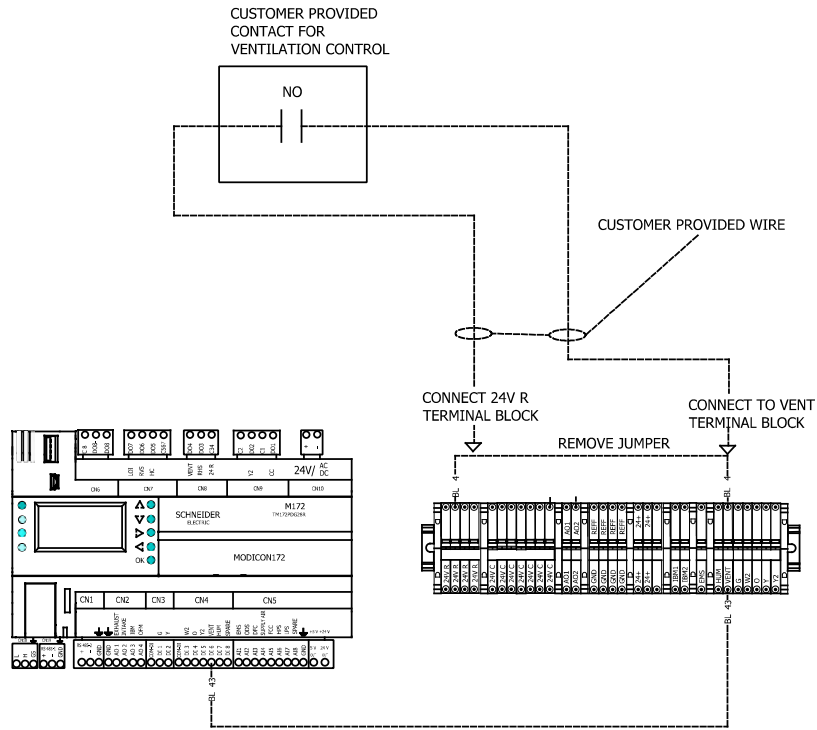
- D. For models with an internal thermostat, no internal control wiring is required. The thermostat is preprogrammed at the factory to maintain a heating mode temperature of 64°F, and a cooling mode temperature of 82°F. To change these settings refer to the directions in installation instructions for the thermostat.
- E. For units with the reheat dehumidification option, the humidity controller (p/n 50057) is remotely mounted on the wall in accordance with the same instructions for the mounting of the wall thermostat installation given in Section 1.12 of this manual. Low voltage leads from the humidity controller are brought into the terminal strip area as shown by routing through the raceway noted in Figure 8, where the “R” lead is connected to the R terminal on the terminal strip. The other lead is connected to HUM on PLC as noted on the wiring schematic of the heat pump.
- F. There is a factory supplied, ¾” plastic drain hose that is left loose in the bottom of the fresh air section of the Scholar QR heat pump and/or air conditioner. Connect the factory installed condensate line the field supplied P-trap. Knockout plate provided on the bottom of the unit for hook-up is located in Figure 3a. All material past the factory installed hose shall be field supplied.
- G. Wet heat hook-ups are done by connecting the rough-in piping to the factory supplied coils inside the plenum.

For hot water heating, the plenum is equipped with a coil and a freeze protection thermostat embedded in the coil. An optional diverter valve may also be factory installed. The front and top panels of the plenums are removable, to access the coil and make piping and wiring connections. Consult hot water plenum installation instructions for installation details or see Appendix C in back of this manual.



**Figure 7. EMS Wiring Detail**

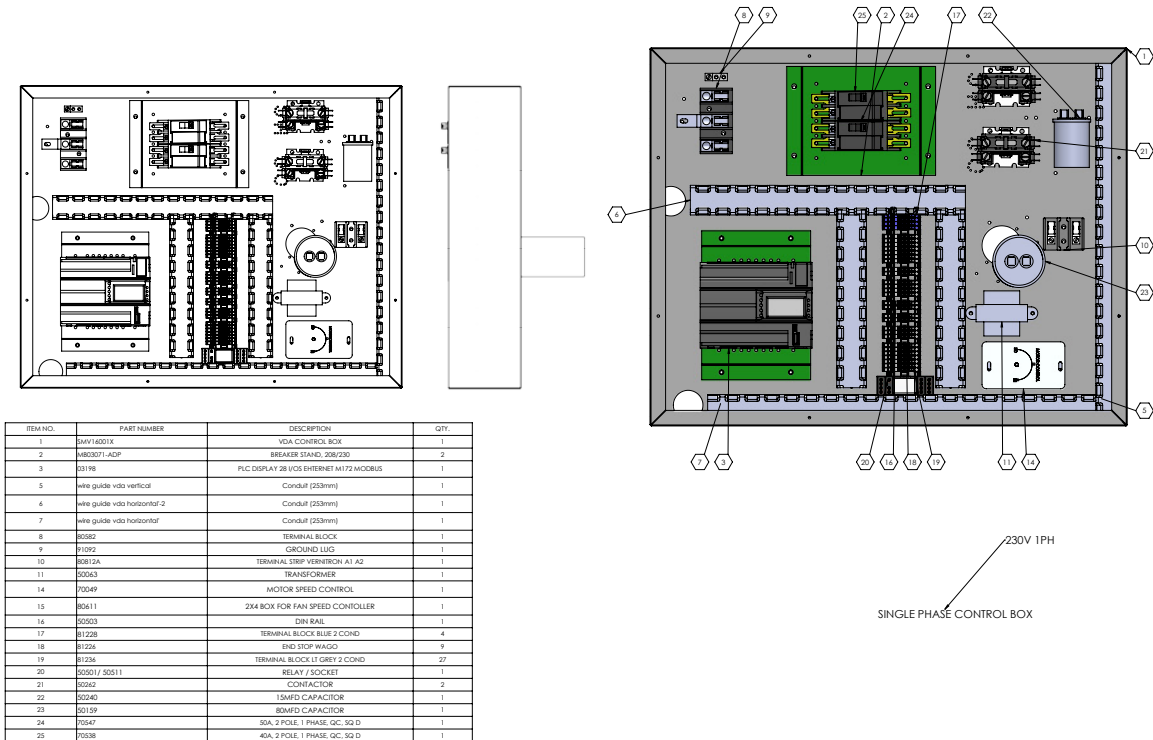
VENTILATION SYSTEM  
INSTRUCTION FOR CUSTOMER VENTILATION CONTROL



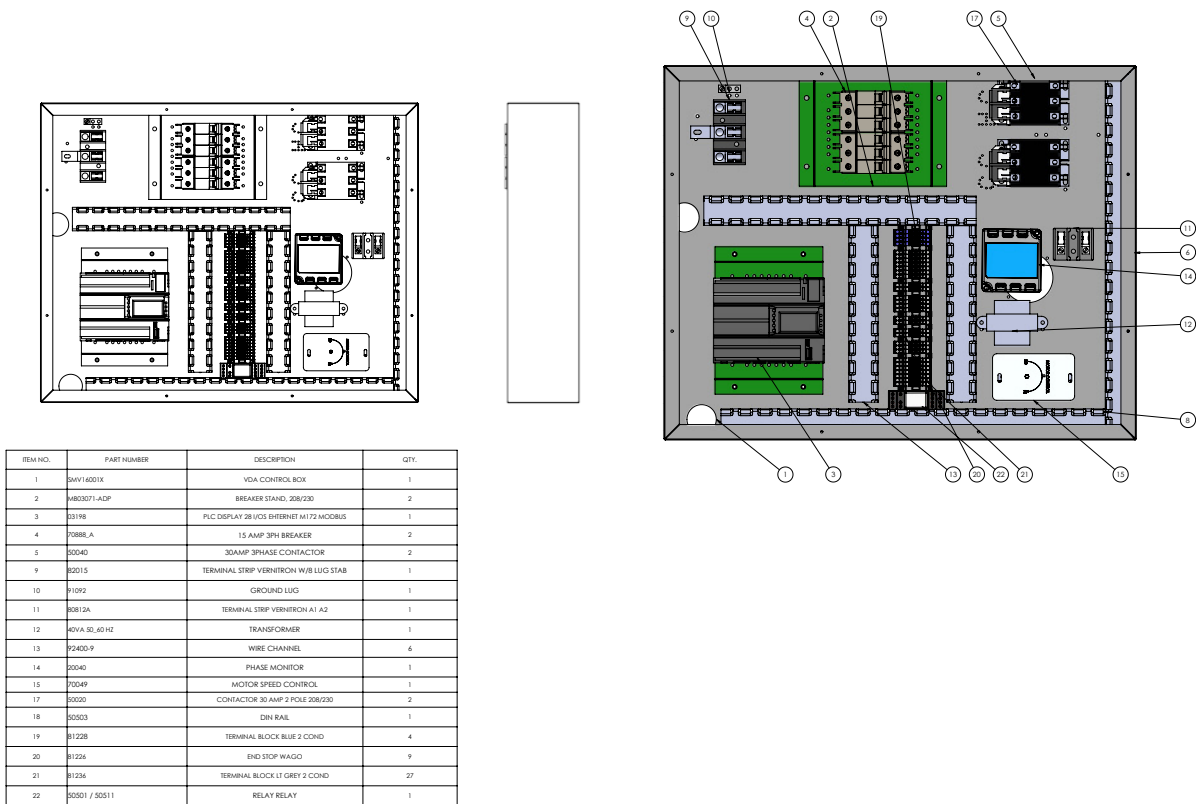
FOR CUSTOMER VENTILATION CONTROL, END USER WOULD NEED TO REMOVE FACTORY JUMPER WIRE #4 FROM "VENT" TO "24V R" TERMINAL BLOCK (DEPICTED ON THIS DIAGRAM) THEY WOULD ALSO PROVIDE THEIR ON NORMALLY OPEN CONTACT.

- 1) WIRE ACCORDING TO THIS DIAGRAM
- 2) REMOVE JUMPER WIRE FROM GWR AND CONNECT ONE SIDE OF THE CUSTOMER NORMALLY OPEN CONTACT TO "VENT" TERMINAL BLOCK AND THE OTHER SIDE TO "24V R"

**Figure 8. Ventilation Controls Wiring Detail**

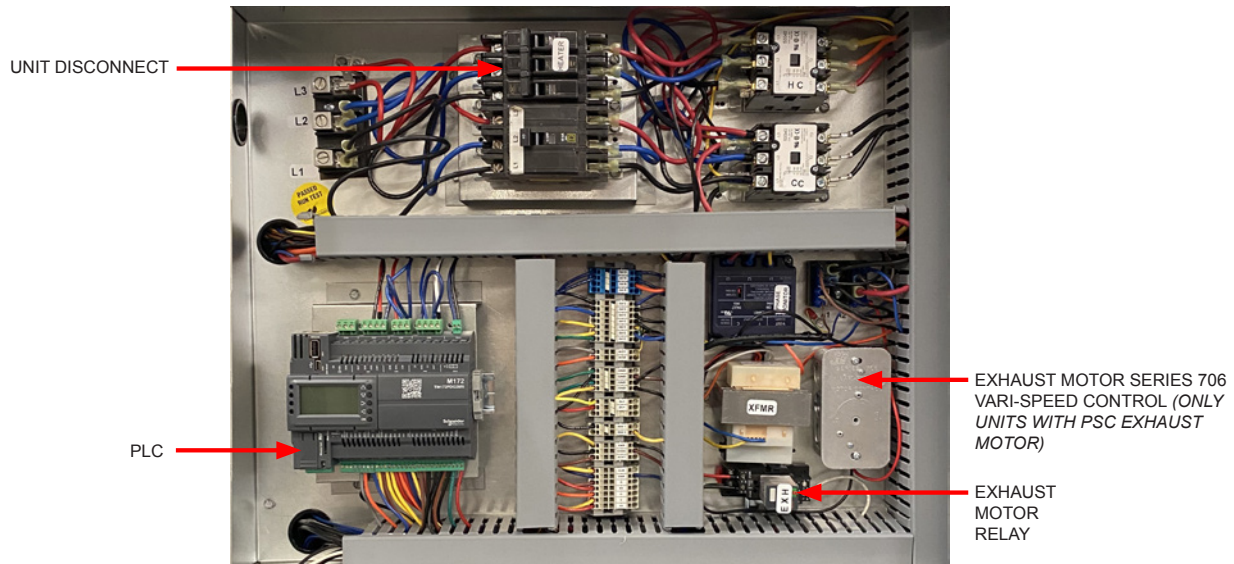


**Figure 9a. Typical Control Center Layout for Single-Phase Scholar QR**



**Figure 9b. Typical Control Center Layout for 3-Phase Scholar QR**

Due to the variety of options, the control center in your unit may be different from this drawing. Always refer to the electrical schematic in your unit. If your Scholar unit does not come with the EHDD and S-CKT wired to the PLC, that means your unit does not need these wires and EHDD and S-CKT can now be selected from the PLC Screen.



**Figure 10. Electrical Control Box**

## Chapter 3: Scholar QR Calibration, Controls & HMI Operation

### 3.1 VENTILATION SYSTEM CALIBRATION

Prior to start-up of the Scholar QR heat pump or air conditioner, the ventilation system requires calibration to ensure the appropriate amount of fresh air is delivered to the classroom. Refer to the appropriate following ventilation system and use the instructions to calibrate the system for correct air delivery.

A. Manual Fresh Air System. This ventilation module is standard with the Scholar QR heat pump and air conditioner. Fresh air ventilation by means of a damper with pressure relief provides up to 450 cfm of outside air. The damper can be manually adjusted at installation to provide the required ventilation airflow.

The fresh air door should be set in accordance with the amount of fresh air flow required, up to a maximum of 450 CFM. Figure 10 illustrates the fresh air door settings and air flow rates.

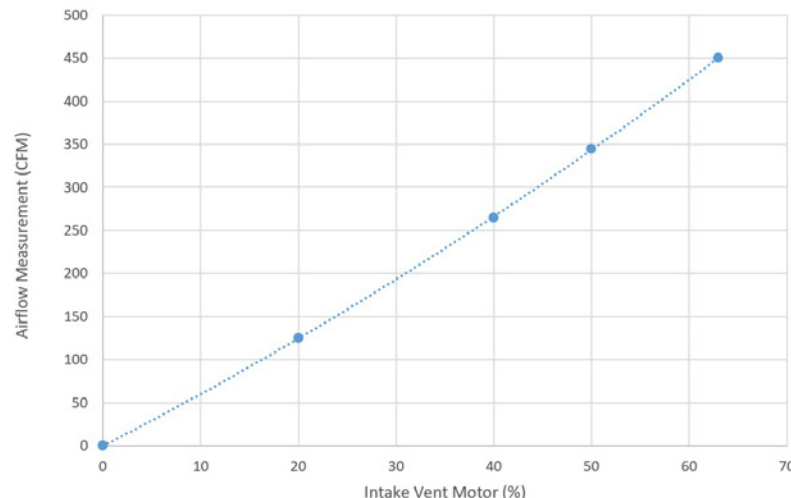
Follow the directions in Figure 10 to ensure proper air flow rate settings. After calibrating the ventilation system, replace the lower front cabinet panel.

B. Two position motorized damper and PowerVent Fresh Air Systems. The two position (open & closed) ventilation module is equipped with a motorized damper and pressure relief, and provides up to 450 cfm of outside air. The damper position can be adjusted at installation to provide the required ventilation air flow. The motorized damper operates by an external relay with a choice of 24, 120, or 240V coils, to regulate fresh air ventilation in response to a control located remotely from the heat pump or air conditioner. The two motorized damper ventilation option includes the ventilation intake air mover and an exhaust fan motor. The intake and exhaust motor speed is adjustable from the HMI screen on the PLC.

This PowerVent ventilation module features a motorized damper, as above, plus powered exhaust ventilation to provide up to 450 cfm of outside air. The damper position can be adjusted at installation to provide the required ventilation air flow. The PowerVent option includes a ventilation air intake air mover.

The fresh air door is opened and closed by the motorized drive. Calibration, as shown in Figure 10, will ensure the required amount of air, up to a maximum of 450 CFM, is delivered to the classroom.

Follow the directions in Figure 11 to ensure the proper air flow rate setting. After calibrating the ventilation system, replace the lower front cabinet panel.





Fresh Air Ventilation Points					
Test #	1	2	3	4	5
Intake Vent Motor %	0	20	40	50	63
Airflow Measure (CFM)	0	125	265	345	450

Airflow Measurement (CFM) vs Intake Vent Motor Setting (%)

### 3.2 PLC CONTROL ADJUSTMENTS

**A. Scholar QR Heat Pump and Air Conditioner PLC (Programmable Logic Controller) Microprocessor.** Essential to the operation of the Scholar QR heat pump and air conditioner is a factory installed PLC microprocessor. The PLC controller improves reliability due to a reduction of components and simplification of the control panel wiring. The PLC is able to:

- Provide various control functions
- Show operational status through the HMI display and LED's
- Assist in troubleshooting
- Perform extensive self diagnosis and indicate a fault
- Store statistical operational data
- Be programmed via USB/RS-495 cable or with a removable program storage device

The PLC is factory wired and tested and typically no adjustments or changes are required to the PLC when the Scholar QR heat pump or air conditioner is installed.

#### B. Location

The PLC is located in the unit control center. Open the front door and remove the cover to the control center.

#### Navigating The PLC Screen

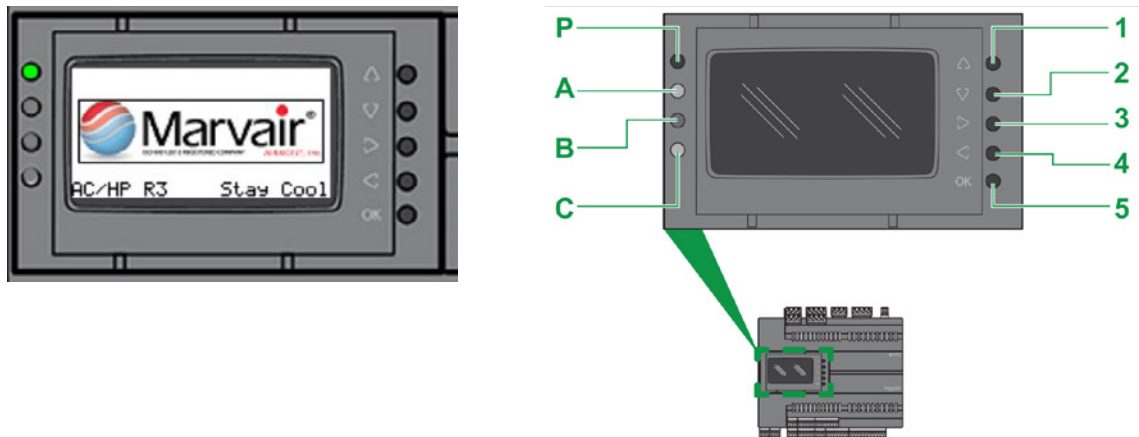
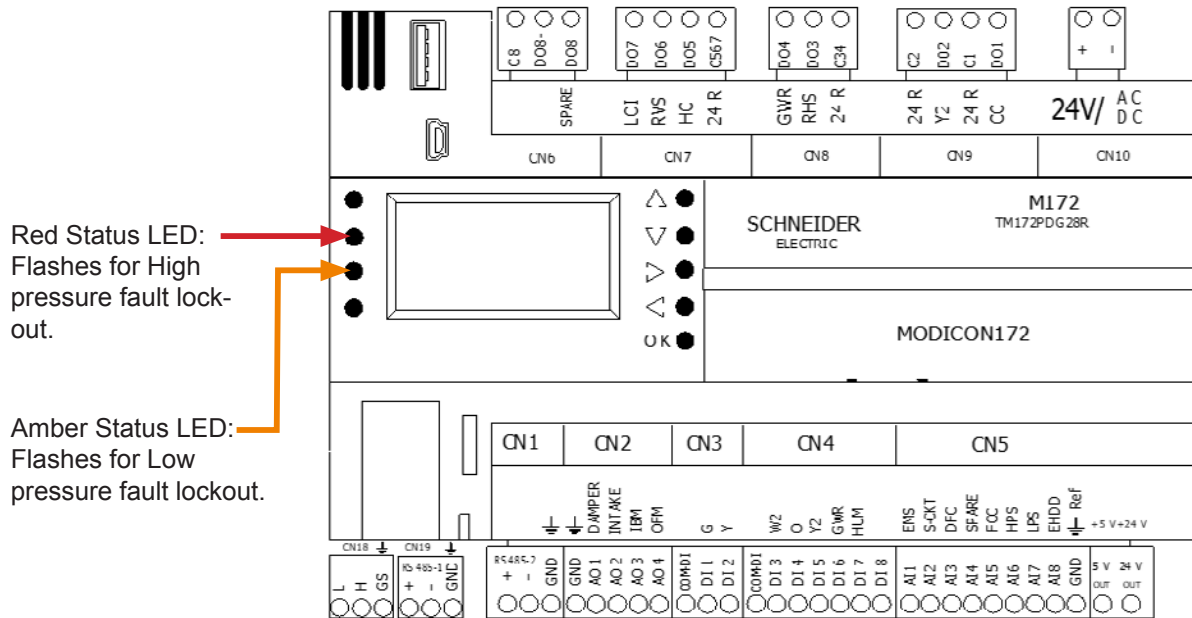


Figure 11. Keys and LEDs

The keys can be programmed from the controller application. In the following table are described the keys default setting (keys are configurable through the logic controller).

Each control can be adjusted by using the directional buttons. **Note:** In “Edit Mode”, the cursor flashes under the value that is going to be modified by the user.

No.	Key	Press Once (press and release)
1	△ UP	<ul style="list-style-type: none"> <li>• Scroll Up</li> <li>• Increase/Modify a Value</li> </ul>
2	▽ DOWN	<ul style="list-style-type: none"> <li>• Scroll Down</li> <li>• Decrease/Modify a Value</li> </ul>
3	▷ RIGHT	<ul style="list-style-type: none"> <li>• Move Cursor Right In Edit Mode</li> <li>• Back to Next Menu/Page</li> </ul>
4	◁ LEFT	<ul style="list-style-type: none"> <li>• Move Cursor Left In Edit Mode</li> <li>• Go Back to Previous Menu/Page</li> <li>• Press and Hold to Exit Edit Mode Without Saving</li> </ul>
5	OK	<ul style="list-style-type: none"> <li>• Enter/Exit Edit Mode</li> <li>• Confirm Operation</li> </ul>

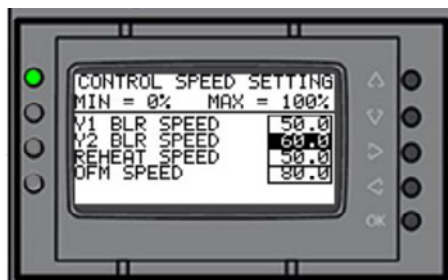


The following table describes the color and function for each of the PLC LEDs.

LED	COLOR	FUNCTION
P	Green	On when Modicon M172 Performance is powered
A	Red	High Pressure Fault
B	Yellow/Amber	Low Pressure Fault / USB Programming
C	Green	USB Programming

**Table 3. LED Function and Colors**

### C. Adjusting Control Speed Parameters



Use the right or left arrow key to navigate to the “Control Speed Settings” screen.

- STEP 1. Use the Up/ Down arrow key to make your selection.
- STEP 2. Press “OK” key to enter, then use the Up/ Down key to change first the value.
- STEP 3. Then use the Left/ Right key to go to the next value.
- STEP 4. Once the desire value is correct, press “OK” key to enter.
- STEP 5. Repeat Steps 1 to 4 to change other values.

#### D. Adjusting Preset Timer Parameters



This screen involves the Anti-short Cycle, Defrost time and Defrost test setting.

**ASCT-TIMER:** Preset values and can be changed default of 3 minutes and with the lowest time of 3 seconds. From there the rest of preset are in 1-minute increments all the way up to 10 minutes.

**DEFROST TIME:** Preset values with a default time of 30 minutes, this can be change from a preset value of 30, 60 and 90 minutes.

**DEFROST TEST:** For testing the defrost function only and should always remain off after testing, this setting only has a “ON” or “OFF” state, which is defaulted to off.

- STEP 1. On the PRESET TIMER screen, use the Up/ Down arrow Key to select which timer to change.
- STEP 2. Then press the “OK” key.
- STEP 3. Then use the Up/ Down arrow key to change the preset time.
- STEP 4. Once the desire time as been selected, press “OK” key to Enter.
- STEP 5. Once the “OK” key is pressed, your new value is now set.

#### E. Adjusting Exhaust Motor Timer



The exhaust motor timer is to adjust the time it takes to Vent (ventilation) output to energized which will then send 24VAC to the exhaust motor relay coil. The default time is 2 seconds, which can be changed from 2, 5 and 10 seconds.

**Note:** Because the times are preset values, the time cannot be manually changed to a undefined value.

- STEP 1. Once on this screen, press the “OK” key.
- STEP 2. Use the Up/ Down arrow Key to change the preset time.
- STEP 3. Once the desire time as been selected, press “OK” key to Enter.
- STEP 4. Once the “OK” key is pressed, your new value is now set.

## F. Exhaust Motor Speed Adjustment

Refer to *Figure 9. Electrical Control Box*

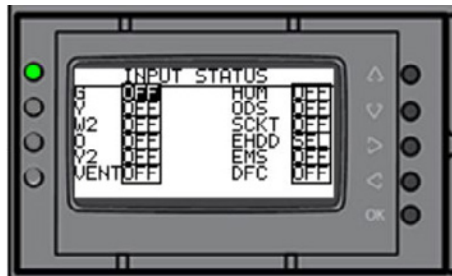
- STEP 1. Insert small flat tip screwdriver into the center of the hole on the Exhaust Motor Speed controller seen in *Figure 9. Electrical Control Box*.
- STEP 2. Turn Clockwise (Right) to increase the speed
- STEP 3. Turn Counterclockwise (Left) to decrease the speed
- STEP 4. Once the desire speed has been adjusted, remove the screwdriver or inserted device

**Note:** Exhaust Fan should be adjusted to user pressure comfort level. If room is being pressurized, increased motor setting until the desired comfort level is reached.

## G. PLC Inputs & Outputs

### A. PLC Inputs

The PLC has inputs located along the bottom of the controller and outputs along the top of the controller. An input is a signal to the PLC from either the thermostat, sensors in the Scholar QR heat pump or air conditioner, or a customer supplied input, e.g., DDC. An output is a signal from the PLC to the heat pump, air conditioner or to the thermostat.



The PLC inputs are powered only by 24 VAC. The thermostat inputs are:

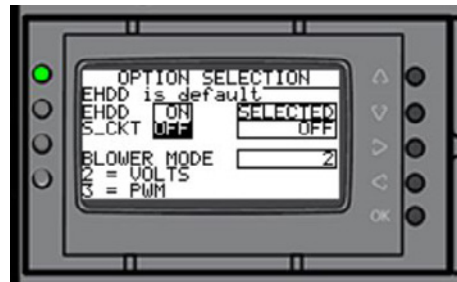
- **G** - Blower signal from thermostat
- **Y** - Compressor
- **W2** - Second stage heat (heat pump function only)
- **O** - Reversing valve (energized for cooling) (heat pump function only)
- **Y2** - Second Stage Cooling/Heating

The PLC has a display screen to show the status of all thermostat inputs and sensors. For example, if the “G” is on, this means that voltage is present from the “G” terminal on the thermostat.

*Scholar QR heat pump and air conditioner sensor or control inputs:*

- **HPS** - High Refrigerant Pressure Switch. The HPS is OFF during normal operation. No light indicates an close switch. See lockout indicator “A” under Outputs.
- **LPS** - Low Refrigerant Pressure Switch. The LPS is OFF during normal operation. No light indicates an closed switch. See lockout indicator “A” under Outputs

- **HUM** - Humidity Controller. Used when an external humidity controller operates the Scholar to control the humidity in the classroom.
- **EHDD** - Electric Heat During Defrost. Allows the user to select whether electric heat operates when the heat pump enters into the defrost mode. The units are programmed at the factory to allow the electric heaters to operate during the defrost mode. For operation during defrost, navigate to the Options screen on the PLC. NOTE: for operation of the electric heat during defrost, the electric heat control must be configured to allow simultaneous operation of the electric heat and the compressor. (heat pump only)
- **SCKT** - “S” Circuit. Signal that indicates the electric heat and the compressor can never operate simultaneously. This function is controlled by selecting SCKT on the PLC screen



- **EMS** - Energy Management System. A shutdown input from an external source.
- **VENT** - When the VENT output is ON, the GreenCube ERV and blower are operating.
- **DFC** - Defrost Control Thermostat. Indicates whether the defrost thermostat is closed. The defrost cycle is based upon both time (see defrost timer) and outdoor coil temperature. (heat pump only)

## H. PLC Outputs



An output is a signal from the PLC to the Scholar QR heat pump or air conditioner or thermostat. All digital outputs on the PLC are 24V. These outputs are:

- **OAM** - Outdoor Air Motor (Fresh air motor for the GreenCube ERV)
- **IBM** - Indoor Blower Motor Relay Note: On early models, this was IFM.
- **VENT** - Ventilation Output
- **RHS** - Reheat Solenoid
- **Y2** - Second Stage Output
- **BLR** - Blower
- **ODS** - Outdoor Sensor, indicate whether this function is enabled = On or disabled = Off

- The next five outputs are 24 VAC. These outputs are:
- **CC** - Compressor Contactor
- **HTR** - Heat Contactor
- **RVS** - Reversing Valve (heat pump only)
- **LOI** - Lock Out Indicator. A blinking LED indicates that a pressure switch has opened. A flash rate of once per second indicates a low pressure switch lockout. A flash rate of twice per second indicates a high pressure lockout.

LOI output DO7 on PLC can be tied in to a customer provided 24V LED or relay for customer notification

- **OFM** - Outdoor Fan Motor Relay

### I. Cooling Mode

During normal operation of the system, the thermostat calls for cooling by turning on the G, Y and O inputs to the system, the Blower will run at Y1 speed, settable on the PLC screen. If 2nd stage signal is requested, the blower will run at the higher Y2 speed settable on the PLC screen. This request will be indicated on the Input Screen on the PLC with G, Y and O set to on. If there is a power surge or someone turns power off and then back on the unit will go through the Anti Short Cycle function this will prevent the compressor from coming back on immediately. Once the compressor has been off for a least the amount of time interval set on the ASCT, the Compressor Contactor (**CC**), Indoor Blower (**IBM**), Reversing Valve (**RVS**) and the Outdoor Fan Motor (**OFM**) output status on the PLC HMI screen should be on. If there is a call for cooling. This indicates that the controller is sending an output signal to turn those devices on.

### J. Heating Mode

When the thermostat calls for first stage heating, it turns on the G, Y, Y2 inputs and Y2 blower speed. The Input and Output screen will indicate the thermostat is calling for heat. If the compressor has been powered off for at least the time set on the ASCT, the Compressor Contactor (**CC**), Reversing valve (**RVS**) and Y2 solenoid for full capacity display “on” on the PLC HMI output screen. The Indoor Blower Motor (**IBM**) and Outdoor Fan Motor (**OFM**) output speed will display the percentage value for their current speed on the PLC HMI output screen.

The Output indicate that the PLC is sending a signal to the devices’ controls. If the thermostat calls for second stage heating (heat pump only), the W2 Input will be on and the HC Output will be on. If the HC Output is on, this indicating that the thermostat is calling for second stage heat. ODS If installed (Optional) and temperature is not below the ODS set point, the second stage heat (**HTR**) will not come on. If the W2 indicator is on and the ODS Output is on then, in addition to the CC, IBM and OFM Output, the HC Output will be on indicating the call for second stage heat. If the SCKT is on indicating that the S Circuit function is selected, the CC and OFM Output will be off and the HC Output will be on. Refer to the following table

G	Y	W2	ODS	SCKT	IBM	CC	OFM	HTR
ON	OFF	OFF	OFF	OFF	ON	OFF	OFF	OFF
ON	ON	OFF	OFF	OFF	ON	ON	ON	OFF
ON	ON	ON	OFF	OFF	ON	ON	ON	OFF
ON	ON	ON	ON	OFF	ON	ON	ON	ON
ON	ON	ON	ON	ON	ON	OFF	OFF	ON

## K. Dehumidification (hot-gas reheat)



The dehumidification process is started when cooling is satisfied and the humidity in the space is above the humidity setpoint set by the humidity control. Once those conditions are met the re-heat valve/ solenoid will energize (**RHS**), based on a settable On and Off supply air temp setpoint (settable from the PLC screen on the “Reheat Option” screen). the compressor will run at full speed (Y1 & Y2) and the Blower (BLR) will run at the reheat speed (default = 50%) settable from the PLC screen. Cooling takes priority over Dehumidification, so once the thermostat is calling for cooling, the dehumidification process will stop and de-energized the reheat valve/Solenoid (**RHS**) and resume cooling.

**Note:** Electric reheat option is only available on AC unit only.

## L. Defrost Mode (heat pump only)



When the system has been operating in the heat pump mode for a period of time (set by the Defrost Timer), the system will examine the Defrost Control thermostat Input (**DFC**). If this input is on (the thermostat is closed), indicated by Output being on, the system will go into Defrost mode based on the defrost time default = 30min (30, 60 & 90min) At this point the Outdoor Fan Motor relay (**OFM**) is de-energized and the reversing valve is energized. In this mode heat is being applied to the outdoor coil to remove any possible buildup of ice on the coil. The Defrost Control Switch (**DFC**) comes on at roughly 28°F and goes off at approximately 56°F. During the Defrost Cycle, the unit will continuously examine the DFC input and when it switches off OR the system has been in defrost for 10 minutes, the system will revert back to normal heating mode. By having a maximum time for the Defrost Cycle to operate, the system will not go into Defrost and remain in Defrost mode if a Defrost Switch malfunctions. If the Electric Heat During Defrost (**EHDD**) function has been selected, the Heat Contactor (**HTR**) will come on to supply supplemental heat during the Defrost Cycle.

**Note:** the defrost time is accumulated, Ex; if the 30min defrost time is selected, that is the time it will take to go into defrost mode. While in defrost if the defrost function is interrupted by a power outage or a sequence , the timer will stop and resume where it left off, so if you had 10 minutes left to go into defrost and there is a power surge, instead of starting over from 30 minutes, the defrost function will now start

at the 20 minute mark and the unit will only have 10 minutes left before it goes into defrost.

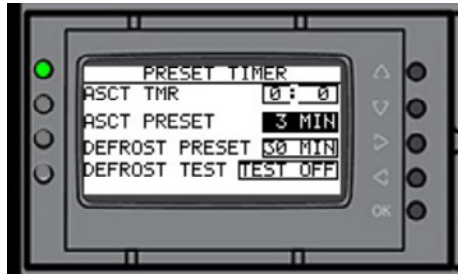
User can also test the defrost function by going to the “Preset Timer” screen and select “Test On”, this will bypass the defrost preset time and go straight into defrost. Which the unit will run in defrost for 10 minutes before it is reset and end the defrost test or user can just turn the test to off. (Keep in mind that in order to test the defrost the unit should be in mechanical heating mode).

### M. Anti-Short-Cycle Timer

The Anti short cycle protects the system compressor from short cycling due to excessive on and off, this can happen when there is a fault or someone turning the system off and on for troubleshooting purpose etc. This timer starts timing when the compressor turns off and prohibits it from running again until the time period as elapsed.

ASCT Settable from PLC screen;

- Minimum = 3 seconds
- Maximum = 10 minutes
- Default = 3 minutes



### N. Defrost Timer (DFT) (heat pump function only)

Located on the “Preset Timer” screen. The defrost control is based upon both time and temperature. The DFT initiates a defrost cycle whenever the outdoor coil temperature is 28°F or below and the selected time interval from the previous defrost cycle has been exceeded. The Defrost time is selectable from the Preset Timer screen from 30 to 90 minutes. The Marvair® factory set point is 30 minutes.

### O. Low Pressure Lockout

The Low Pressure Switch is designed to guard against the operation of the system in the event of a loss of refrigerant. If the Low Pressure switch is open the system will shut down with a Low Pressure fault, indicated by a flashing amber LED on the PLC. The interval for the flash is once per second. Once the switch is closed being that there is still a call for cooling the unit will resume operation. In cold weather the pressure in the refrigerant system is low prior to operation. When the Scholar QR unit starts in the heat pump mode during cold weather, low pressure could cause the system to lock out. To guard against nuisance lockouts, the Scholar QR unit will not shut off if the Low Pressure Switch (LPS) comes on during the first three minutes bypass time of operation. In other words, the compressor will start and operate for three minutes even with the LPS switch open. Once the bypass timer has elapse and the LPS is closed the system will continue to operate, if the LPS is open twice on the same call for cooling the system will go into a lock out mode.

### P. High Pressure Switch

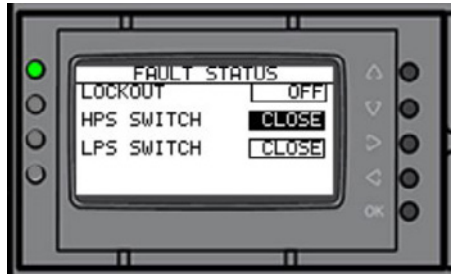
The system has a High Pressure Switch (HPS) that indicates a high system pressure. If there is an HPS fault or the HPS is open during operation the system



will shut down with a High Pressure fault, indicated by a flashing Red LED on the PLC. Once the switch is closed being that there is still a call for cooling the unit will resume operation. If the HPS is open twice on the same call for cooling the system will go into a lock out mode.

### Q. Troubleshooting

The PLC is a microprocessor-based system that has the ability to provide a great amount of information to aid in troubleshooting a malfunctioning system. With the Input and Output screen user can easily diagnose most problem by just seeing what is on and or what is off.



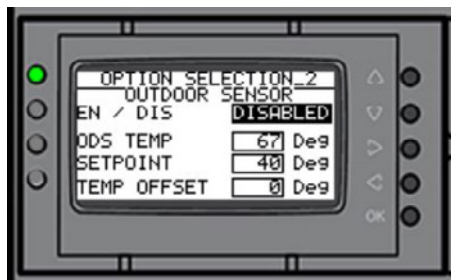
### R. Normal Operation

The High Pressure Switch (HPS) and Low Pressure Switch (LPS) should be close all the time. An exception will be during a low temperature start-up during which the LPS should come on within a few moments of start-up. The chart below shows the standard inputs and what functions should be on as a result.

	OAM	IBM Y1 SPEED	IBM Y2 SPEED	VENT	RHS	CC	HTR	RVS	Y2 SOL	A (ALARM)	OFM
G		X									
Y						X	X If SCKT is on				X
Y2			X						X		X
W2			X				X				
O								X			
HPS										X if HPS is open	
LPS										X if LPS is open	
HUM		X			X	X		X	X		X
EHDD							X If system is in Defrost Mode				
S-CKT							X If Y is on due to a call for heat				
ODS							X If calling for heat (Optional)				
EMS											
VENT	X If jumper is in place or tied into external control & Reheat disabled	X		X If jumper is in place or tied into external control & Reheat disabled							
DFC								X			

X - Indicates that this function should be on

1. **Outdoor Thermostat (heat pump only).** Factory set at 40°F, this thermostat determines the outdoor temperature at which the supplemental electric heat or wet heat turns on. This may be field adjusted to the desired temperature setting by changing the settings on the PLC option selection screen.



## Operation Guide



<http://go2se.com/ref=TM172PDG28S>

Scan this QR Code for the full PLC Operation Guide

# Chapter 4: Scholar QR Networking and Remote Communication

## 4.1 BACNET INFORMATION

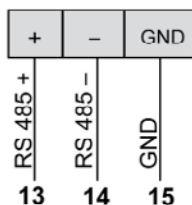
This section serves as a reference for the BACnet Information on the VDH units. Below are all the Analog and Boolean points that are Read/ Write and Read only. BACnet device ID & IP address can be configured over BACnet network or locally on the PLC screen to address multiply units over BACnet network.

- BACnet Device ID: 0 (Default)
- BACnet IP Port: 47808
- PLC IP Address: 10.0.0.100 (Default)

MARVAIR VDH UNIT BACNET POINTS	
(Read/Write)	(Read Only)
<b>BACnet Input Boolean Points</b>	<b>BACnet Output Boolean Points</b>
• G IN	• CC
• Y IN	• HC
• Y2 IN	• IBM
• O IN	• OFM
• W2 IN	• RVS
• HUM IN	• RHS
• VENT IN	• OAM
• EMS IN	• Y2
<b>BACnet Motor Analog Values</b>	<b>BACnet Output Analog Values</b>
• G/Y1 SPEED	• OUTDOOR FAN SPEED
• Y2 SPEED	• BLOWER SPEED
• HUM SPEED	• OUTDOOR TEMP
• INTAKE MOTOR SPEED	• SUPPLY AIR TEMP
• OFM MOTOR SPEED	
	<b>BACnet Alarms Status Points</b>
	• LPS
	• HPS
	• LOI
	• EMS

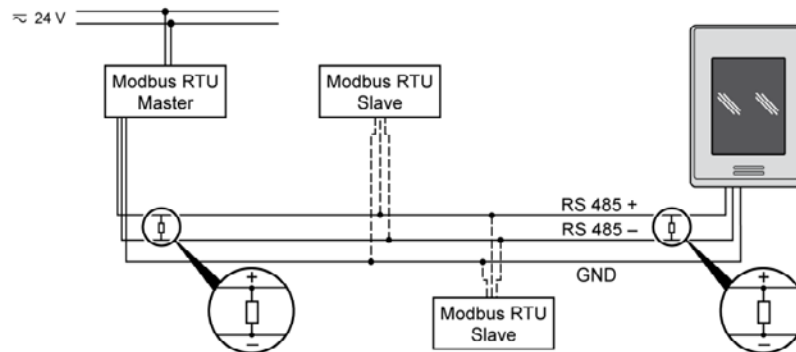
## 4.2 RS-485 MODBUS SERIAL PORT

1. **Overview.** The TM172DCL\*\*\*\* can be connected to the controller through the RS-485 Modbus.
2. **Connector.** RS-485 connector (CN3):

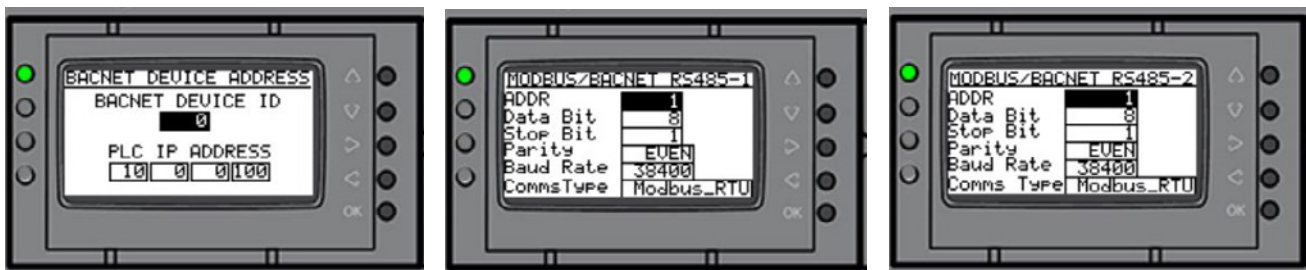


**Note:** GND of the RS-485 terminal is not internally connected to the “-” of the power supply terminal of the device.

- Architecture Wiring Examples.** The following diagram shows an RS-485 (field) architecture wiring example:



- Communication Settings.** Modbus/BACnet ID, PLC address and RS-485 port 1 and port 2 settings.



### 4.3 ETHERNET PORT

- Overview.** Each TM172P controller is equipped by an RJ45 Ethernet port.
- Description.** The Ethernet port permits user to connect the device to:
  - Different controllers and/or applications exchanging variables and/or parameters (network)
  - A supervision system using Modbus TCP/IP protocol
  - An IEC 61131-3 EcoStruxure Machine Expert - HVAC software development system
  - A BACnet/IP network, with B-AAC profile

Concurrent communication of different protocols using the same Ethernet port is allowed (use of a web browser in addition to another Ethernet Fieldbus connection, for example).

- Web Functionalities.** The M172P also features Web functionalities, offering makers of machinery and systems integrators remote access. Having a web-based connection in machines reduces support and maintenance by minimizing call-out charges. End users also benefit, as they can monitor their own systems both locally and from distance, using the graphics interface of any browser.

Main Web functionalities:

- Web-based access.
- Remote reading and support.
- Local and remote system control, including alarms management.
- Preventive and predictive maintenance.
- Email alarm alerts.

Care must be taken and provisions made for use of this product as a control device to avoid inadvertent consequences of commanded machine operation, controller state changes, or alteration of data memory or machine operating parameters.

 **WARNING**

**UNINTENDED EQUIPMENT OPERATION**

- **CONFIGURE AND INSTALL THE MECHANISM THAT ENABLES THE REMOTE HMI LOCAL TO THE MACHINE SO THAT LOCAL CONTROL OVER THE MACHINE CAN BE MAINTAINED REGARDLESS OF THE REMOTE COMMANDS SENT TO THE APPLICATION.**
- **YOU MUST HAVE A COMPLETE UNDERSTANDING OF THE APPLICATION AND THE MACHINE BEFORE ATTEMPTING LO CONTROL THE APPLICATION REMOTELY.**
- **TAKE THE PRECAUTIONS NECESSARY TO ASSURE THAT YOU ARE OPERATING REMOTELY ON THE INTENDED MACHINE BY HAVING CLEAR, IDENTIFYING DOCUMENTATION WITHIN THE APPLICATION AND ITS REMOTE CONNECTION.**


**FAILURE TO FOLLOW THESE INSTRUCTIONS CAN RESULT IN DEATH, SERIOUS INJURY, OR EQUIPMENT DAMAGE.**

4. **Bridge.** EcoStruxure Machine Expert - HVAC software allows monitoring of Modbus/RTU slaves, where M172P controller is the master Modbus/RTU.

In a EcoStruxure Machine Expert - HVAC software project, M172P controller is used as a Modbus TCP to Modbus/RTU protocol conversion element for Mod bus 03<sub>h</sub> and 1 O<sub>h</sub> commands.

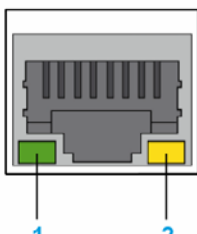
From EcoStruxure Machine Expert - HVAC software, set the connection with the device as Modbus TCP, inserting the M172P controller IP address and the Modbus/RTU address of the device slave.

5. **Connector.** RJ45 Ethernet pin assignment:

 <b>Cable Length:</b> 100m (328 ft)	Pin Number	Signal
	1	TD+
	2	TD-
	3	RD+
	4	-
	5	-
	6	RD-
	7	-
8	-	

**Note:** The controller supports the MDI/MDIX auto-crossover cable function. It is not necessary to use special Ethernet crossover cables to connect devices directly to this port (connections without an Ethernet hub or switch).

- 6 **Status LED.** RJ45 Ethernet Status LED

	Label	Signal	LED		
			Color	Status	Description
	1	Ethernet Link	Green/Yellow	Off	No Link
				Yellow On	Link at 10Mb
				Green On	Link at 100Mb
2	Ethernet Activity	Green	Off	No Activity	
			Flashing	Activity	

# Chapter 5 Optional Electronic Control Board

## 5.1 Introduction

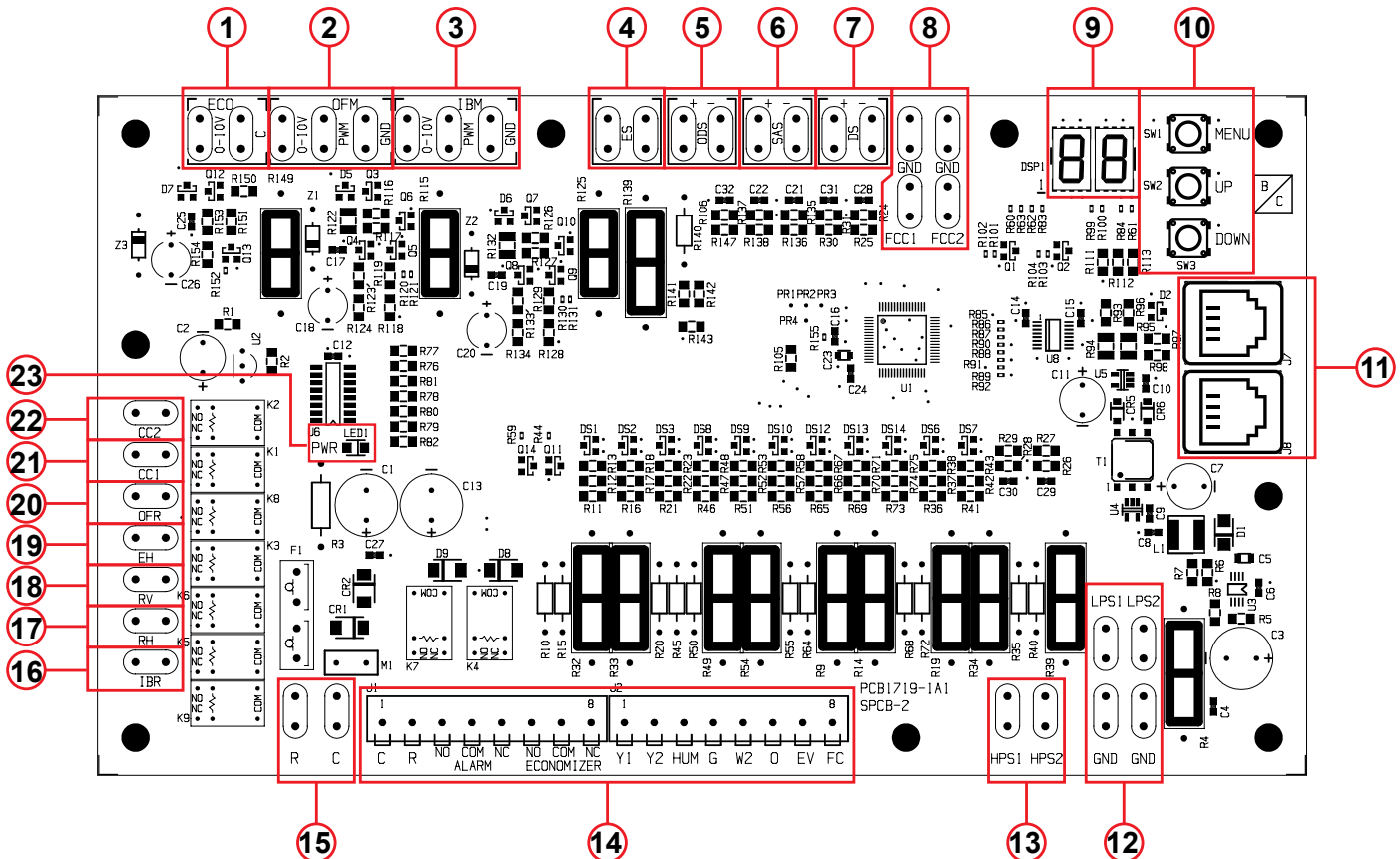


**WARNING**

**FAILURE TO OBSERVE THE INSTRUCTIONS CONTAINED IN THIS DOCUMENT MAY RESULT IN PERSONAL INJURY AND/OR PROPERTY DAMAGE AND MAY VOID THE WARRANTY. READ THIS MANUAL BEFORE INSTALLING, REPLACING OR USING THIS PRODUCT.**

Marvair's proprietary Printed Circuit Board (PCB) sets the standard for the industry in flexibility, reliability and performance. This UL certified component is engineered to optimize Heating, Cooling and Dehumidification operation while communicating valuable information to the end user. Special features include 2-Stage operation with varying speed control to optimize latent and sensible capacity, built in remote communication (Modbus) for monitoring and/or control, optimized head pressure control and configurable menu options for various operations and control. The Marvair PCB comes equipped with seven segment display to annunciate faults, which drastically reduces troubleshooting time and system downtime. Lockout contacts are also provided along with the alarms being transferred via Modbus.

This chapter provides the necessary information for installing and operating the Marvair PCB. The diagram below identifies the inputs, outputs and connections for the Marvair PCB. See I/O table.



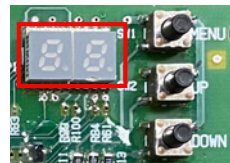
I/O Table for Control Board	
Item	Description
1	Economizer Actuator Output 2-10 VDC
2	Outdoor Motor Control Output 0-10 VDC or PWM
3	Indoor Motor Control Output 0-10 VDC or PWM
4	Enthalpy Sensor Signal Input 4-20mA
5	Outdoor Sensor Signal 10K NTC (Heat Pumps) / Dry Bulb Sensor Signal Input 10K NTC (Systems Equipped with Dry Bulb Economizer)
6	Supply Air Sensor Signal Input 10K NTC (Systems Equipped with Economizer)
7	Defrost Sensor Signal Input 10k NTC (Heat Pumps Only)
8	Head Pressure Control Sensor Signal 10k NTC (ECM Motors)
9	Control Board Menu/Fault Display
10	Menu/Up/Down Selection Buttons
11	Modbus RJ11 Communications Ports
12	LPS 1 = Freeze Sensor Input 10K NTC   LPS 2 = Not currently used (Software version 16 and later)
13	HPS 1 = High Pressure Switch Input (Normally Closed) HPS 2 = Low Pressure Switch Input (Normally Closed) (Software Version 16 and later)
14	Thermostat Inputs/Alarm And Status Terminals
15	24 VAC To Power Board (18 VAC To 30 VAC)
16	Indoor Blower Output 24 VAC (PSC Motors)
17	Reheat Output 24 VAC (Hot Gas Or Electric Reheat Dehumidification)
18	Reversing Valve Output 24 VAC (Heat Pumps Only)
19	Electric Heat Output 24 VAC
20	Outdoor Fan Output 24 VAC (PSC Motors)
21	Compressor 1/1st Stage Output 24 VAC (Single Stage Compressor)
22	Compressor 2/2nd Stage Output 24 VAC (Dual Compressor System 2nd Compressor) (Single Compressor 2nd Stage)
23	Control Board Power Indicator LED

## 5.2 Installation and Replacement

The PCB is factory installed. To install a replacement PCB, use the six mounting holes along with the appropriate screw size to firmly secure the board to the control box. After this is achieved, follow the wiring diagram and menu configuration for the respective system for appropriate operation. Ensure that the terminals used do not make any unwanted electrical connection (via strands etc.) with any other terminals. Please allow a 1" creepage distance between the board and all other adjacent electrical components.

## 5.3 PCB Details and Information

The PCB is equipped with an on board seven-segment display (Item #9) for configuring various settings and displaying faults. During normal operation the display remains off unless the configuration menu is accessed or a fault has occurred. Faults will be annunciated on the display as shown below:



Display	Displayed Faults
AS-F	Supply Air Sensor Fault (sensor disconnected or faulty) if equipped
DB-F	Dry Bulb / Outdoor Sensor Fault (sensor disconnected or faulty) if equipped
DS-F	Defrost Sensor Fault (sensor disconnected or faulty) Heat Pumps Only
ES-F	Enthalpy Sensor Fault (sensor disconnected or faulty) if equipped
EF	Emergency Fan / Ventilation Active
FS	Freeze Sensor Fault
LP-1F	Low Pressure Lockout
HP-Lc	High Pressure / Loss of Charge Lockout
o3	Low Voltage "Brownout" 16vac or less for 10 minutes

### 5.3.1 – Programming Menu Configuration

1. To Enter Programming Mode:
  - Press and hold the *Menu* button for 5 seconds until **P-01** is displayed.
2. While in Programming Mode main menu:
  - Press the *Menu* button to enter the displayed parameter menu.
  - Press the Up/Down buttons to adjust the current parameter number.
  - The current parameter number will be displayed seven segments alternating showing “P-” and the number every 0.5s.
3. While in parameter menu:
  - The current parameter selection will be displayed seven segments.
  - Press the *Menu* button to save the current parameter selection return to the programming main menu.
  - Press the Up/Down buttons to adjust the current parameter selection.
4. To exit programming mode, press and hold the *Mode* and *Up* buttons while in the programming main menu.
  - Press and hold the *Menu* button for 5 seconds.
  - **Note:** The control will automatically exit the programming mode after 2 minutes with no activity.

**Note:** 100 will be displayed by alternating between “1” and “00” every 0.5s.

Configuration Menu				
Menu Setting	Name	Default	Selections	General Description
1	System Type	AC	AC, HP	HP = Heat Pump, AC = AC Unit (Factory Set)
2	IBM Select	P	P, DC	P = PWM, DC = 0-10V (Factory Set)
3	Fan Purge	90	N, 10-90	IBM P = PWM, dC = 0-10V and IBR Off Delay in Seconds
4	IBM G Set	60	30-100	G Call for Indoor Blower Speed Setting
5	IBM Y1 Set	80	40-100	1st Stage Cooling Indoor Blower Speed Setting
6	IBM Y2 Set	100	40-100	2nd Stage Cooling Indoor Blower Speed Setting
7	OFM Select	P	P, DC	P = PWM, DC = 0-10V (Factory Set)
8	OFM Set	80	65-100	Outdoor Fan Motor Max Speed Setting
9	Defrost Timer	30	30, 60, 90	Defrost cycle timer in minutes
10	EHDD Select	Y	Y, N	CAN ONLY BE "Y" IF SCKT IS "N" (Electric Heat During Defrost)
11	SCKT Select	N	Y, N	SCKT= Y OVERRIDES EHDD (Safety Circuit)
12	ODS Set	50	0-70	Outdoor Sensor for Electric Heat Enable Setpoint HP ONLY
13	ECONO Select	N	Y, N	N = Disabled (No Econo.), Y = Enabled (W/Econo.)
14	Sensor Type	EN	EN or DB	Economizer sensor type selection EN= Enthalpy, DB = Dry Bulb
15	ECONO Set	D 70	A-E 20F - 105F	Selections A=73F, B=70F, C= 67F, D =63F E= 55F all @ 50%RH (Only available if EN sensor type is selected) Dry Bulb 20F to 105F
16	MIN POS	20	20-100	Sets the damper position for Minimum Open
17	W2 Speed	100	70-100	Sets the Indoor Blower Speed for Electric Heat
18	Dehum Speed	80	60-100	Sets the Indoor Blower Speed for Dehumidification
19	Pulse Reheat	Y	n/Y	Y = Pulsing reheat @ Dehum Supply Set N= On/Off reheat
20	Dehum Supply Set	72	70-75	Supply Air Setpoint for Dehumidification w/ 5F off differential
21	DS Calibration	0	-18	Defrost Sensor Calibration
22	MAS Calibration	0	-18	Supply Air Sensor Calibration
23	T'STAT Select	H	H, C	H = hardwired 24V tstat, C = communicating tstat
24	MODBUS ID	1	1 to 99	Sets the Modbus ID for the unit
25	MODBUS BAUD rate	19	9.6, 19	Available Baud Rates 9.6 = 9600, 19 = 19200
26	MODBUS Timeout	10	1 to 60	Communications Timeout in minutes
27	Head Press. Cutout	85	75-95	Sets Head Press Min Cutout Temp adjustable in 1F increments
28	Test	N	Y, N	Set to “Y” all timers are reduced for testing (Resets after 10 min.)
29	SW version number	N/A	N/A	Displays the current version software



## Configuration Menu Details

1. **System Type:** This setting allows the PCB to be configured for AC (air-conditioner) or HP (heat-pump). The system type is configured at the factory during production testing for the appropriate system type. The default system type is AC.
2. **IBM Select:** This setting allows the IBM (Indoor Blower) control signal to be configured for PWM or 0-10vdc control. The default control output signal is PWM.
3. **Fan Purge:** This setting allows the delay off time of the indoor blower once the call for the indoor blower has been removed. The selections are N (no delay) or 10-90 seconds. After the default time of 90 seconds the indoor blower will shut off. Selecting the N (no delay) will allow the Indoor blower to shut off immediately after any request has been removed.
4. **IBM G Set:** This is an independent setting for the speed at which the Indoor blower will operate upon a request for G (Fan Only) via Digital Input or MODBUS. The default setting for the IBM G Set is 60% of maximum speed. The speed may be adjusted from 30-100% in 1% increments to meet desired airflow requirements.
5. **IBM Y1 Set:** This is an independent setting for the speed at which the Indoor blower will operate upon a request for Y1 (1st stage cooling) via Digital Input or MODBUS. The default setting for the IBM Y1 Set is 80% of maximum speed. The speed may be adjusted from 40-100% in 1% increments to meet desired airflow requirements.  
**Note:** Adjusting the speed too low will result in coil freezing.
6. **IBM Y2 Set:** This is an independent setting for the speed at which the Indoor blower will operate upon a request for Y2 (2nd stage cooling) via Digital Input or MODBUS. The default setting for the IBM Y1 Set is 100% of maximum speed. The speed may be adjusted from 40-100% in 1% increments to meet desired airflow requirements.  
**Note:** Adjusting the speed too low will result in coil freezing, low-pressure or high-pressure lockout.
7. **OFM Select:** This setting allows the IBM (Indoor Blower) control signal to be configured for PWM or 0-10vdc control. The default control output signal is PWM.
8. **OFM Set:** This is an independent setting for the max speed at which the Outdoor fan will operate. The default setting for the OFM Set is 80% of maximum speed. The speed may be adjusted from 65-100% in 1% increments to meet desired airflow requirements.  
**Note:** Adjusting the speed too low will result in coil freezing, low-pressure or high-pressure lockout.
9. **Defrost Timer:** The defrost timer only applies to Heat-pump systems (when setting 1 is set to HP). This is the accumulation timer used to monitor for heat-pump defrost control. The selections for defrost timing is 30, 60 and 90 minutes. The defrost timer accumulates the compressor runtime in the heat-pump mode and monitors the defrost sensor for freezing conditions to initiate a defrost cycle at the selected defrost timing interval. The default defrost time is 30 minutes.
10. **EHDD Set:** The Electric heat during defrost setting allows the electric heat to operate when a defrost cycle is being performed in heat-pump mode. The selections for the EHDD Set are Y (yes) or N (no). When set to N (no) the electric heat will not operate automatically during a defrost cycle in heat-pump mode. When the EHDD Set is set to Y (yes, Default) the electric heat will operate upon each defrost cycle in the heat-pump mode.  
**Note:** EHDD and SCKT cannot both be set to the Y (yes) selection at the same time. SCKT takes priority over EHDD.

**11. SCKT Set:** The SCKT setting is used to prevent simultaneous operation of the electric heat and compressor. The selections for the SCKT Set are Y (yes) or N (no). When set to N (no, Default) the electric heat will be allowed to operate with the compressor in heat-pump mode upon a call for W2 (auxiliary / emergency heat). When the SCKT Set is set to Y (yes) the electric heat will not be allowed to operate with the compressor in the heat-pump mode. When set to Y (yes) and upon a request for W2 (auxiliary / emergency heat) the compressor will shut off and the electric heat will operate.

**Note:** SCKT and EHDD cannot both be set to the Y (yes) selection at the same time. SCKT takes priority over EHDD.

**12. ODS Set:** The ODS Set is used to set the Outdoor Sensor temperature for Heat-pump systems. When the system type is configured for Heat-pump (when setting 1 is set to HP), the ODS Set allows the outdoor sensor to be used to govern when electric heat is allowed to operate. When the outdoor temperature is below the ODS setpoint, the electric heat will be allowed to operate. The adjustable range is 0F-70F in 1F increments with a default setpoint of 50F.

**13. ECONO Select:** The ECONO Select is used to select whether the system has an economizer system installed or not. When set to the Y (yes) selection the system will include the economizer cooling algorithm within its sequence of operation and utilize the economizer package when conditions are favorable for economizer cooling. When set to the N (no) selection the system will only utilize the compressor for cooling operation. This setting is configured at the factory during production testing for the appropriate system type.

**Note:** When ECONO Set is set to Y (yes) the system must have an Enthalpy or Dry Bulb and Supply Air sensor connected and properly selected in setting 13 in order to operate in economizer cooling. The system will default to compressor cooling if any sensor becomes disconnected or faulty. Changing the ECONO Select to N (no) will disable economizer operation and the economizer function will be ignored.

**14. Sensor Type:** This setting is used for selecting the type of economizer sensor used EN (Enthalpy) or DB (Dry Bulb). The appropriate sensor must be connected and selected for economizer operation. This setting is configured at the factory during production testing for the appropriate sensor type.

**15. ECONO Set:** This setting is used to set the economizer setpoint at which the economizer is allowed to operate for cooling. When setting 13 is set for EN (Enthalpy), the selections are A= 73F, B=70F, C=67F, D=63F and E=55F all at 50% relative humidity. The A – E selections will only be available when setting 13 is set to EN (Enthalpy). When setting 13 is set for DB (Dry Bulb), the selection is from 20F to 105F in 1F increments. The 20F-105F range will only be available when setting 13 is set to DB (Dry Bulb).

**16. MIN POS:** The MIN POS setting is for setting the minimum position of the economizer or motorized damper. When set above 20 (2vdc) the damper will remain open to the selected position at all times, hence minimum position. The adjustable range is from 20 (2vdc) to 100 (10vdc) in 1vdc increments.

**17. W2 Speed:** This is an independent setting for the speed at which the Indoor blower will operate upon a request for W2 (Electric heat) via Digital Input or MODBUS. The default setting for the W2 speed is 100% of maximum speed. The speed may be adjusted from 70-100% in 1% increments to meet desired airflow requirements.

**Note:** Adjusting the speed too low will result in increased supply air temperatures in electric heat mode.

- 18. Dehum Speed:** This is an independent setting for the speed at which the Indoor blower will operate upon a request for HUM (Dehumidification) via Digital Input or MODBUS. The default setting for the Dehum speed is 80% of maximum speed. The speed may be adjusted from 60-100% in 1% increments to meet desired airflow requirements.
- 19. Pulse Reheat:** This setting allows the dehumidification output “RH” to be cycled On and OFF based on the Dehum Supply temperature setpoint. The Options are Y= Yes or N= No and the default is Y.
- 20. Dehum Supply Set:** This setting allows the target setpoint for the supply air temperature during dehumidification operation. The setpoint range is adjustable from 70F to 75F with a fixed differential of 5F. The default setpoint is 72F
- 21. DS calibration:** This setting is used to calibrate the defrost sensor from 0 to -18F.
- 22. SAS calibration:** This setting is used to calibrate the supply air sensor from 0 to -18F.
- 23. T’STAT Select:** The thermostat type can be selected with this setting for an option of H= Hardwired 24vac Thermostat or C = Communicating Thermostat via Modbus. The default setting is H= Hardwired 24vac Thermostat.
- 24. Modbus ID:** This setting allows the Modbus ID to be entered for Modbus communications for the unit. The range for the Modbus ID is 1 – 36161 the default Modbus ID is 1.
- 25. Modbus Baud Rate:** This setting allows the Modbus Baud Rate to be entered for Modbus communications. The available Baud Rates are 9.6= 9600 and 19= 19200. The default Modbus Baud Rate is 19 = 19200.
- 26. Modbus Timeout:** This is the setting for the Modbus communications timeout in minutes. The range of communications timeout is from 25 minutes to 21916 minutes. The default communications timeout is 25 minutes.
- 27. Head Pressure Cutout:** This setting allows the cutout temperature for head pressure control to be adjusted from 75F to 95F in 1F increments. The Liquid line sensor is monitored for head pressure control to modulate the outdoor fan motor. When the sensor temperature reaches the cutout setpoint, the outdoor fan will begin operation. As the liquid line temperature rises the speed of the outdoor fan will increase as needed to maintain a minimum operating speed. The outdoor fan will decrease speed as the temperature decreases closer to the cutout setpoint until the liquid line temperature drops below the head pressure control cutout setpoint. The default head pressure control cutout temperature is 85F.
- 28. Test:** The Test feature has two options Y= Yes or N= No. When this setting is set to Y=Yes, all circuit timers are reduced to expedite testing for various system operations. When set to N=No, all circuit timers are used in their default configuration and normal operation.
- 29. Software Version Number:** The software version of the 92589-control board will be displayed on the seven-segment display. This is for informational purposes only.

## 5.4 Operation

### Power

The Marvair PCB requires 24 VAC to operate. When the board is sufficiently powered, the “PWR” status light on the PCB illuminates “Green.” When the power supply voltage is 16vac or less for 10 seconds the control board will de-energize all outputs. This is considered a voltage brownout (low voltage) condition and the display of the control board will show “03” as an indicator of brownout (low voltage). When the voltage rises back to 17 VAC, the control board will allow the system to operate.

**Note:** The nominal power supply for the control board is 24 VAC and this voltage should be confirmed during startup to assure normal operation.

## **Communication**

The Marvair PCB comes equipped the Modbus communications standard. There are 2 adjacent RJ11 Modbus communication ports connected in parallel. That is, both ports transmit the same information. The board allows you to set the Baud Rate at 9600 bits per second or 19200 bits per second. The board also allows the Modbus ID to be selected in the configuration menu with the available range from 1 to 36161. The default Modbus ID is 1. See *section 5.1 for reference*.

## **5.5 Sequence of Operation**

### **IMPORTANT**

**All equipment should go through the recommended commissioning/start up sequence to ensure safety and system reliability. This document is only valid if the system is used as intended.**

This section defines the manner and method of control of the HVAC system. It will cover the following operations and protections.

#### **1.0 Indoor Blower Operation**

- 1.1 G - Indoor Blower Only
- 1.2 Y1 - Indoor Blower Operation
- 1.3 Y2 - Indoor Blower Operation
- 1.4 W2 – Indoor Blower Operation
- 1.5 HUM – Indoor Blower Operation

#### **2.0 Cooling Operation AC / HP**

- 2.1 Mechanical Cooling (AC systems)
  - 2.1.1 Partial Capacity
  - 2.1.2 Full Capacity
- 2.2 Mechanical Cooling (HP systems)
  - 2.2.1 Partial Capacity
  - 2.2.2 Full Capacity

#### **3.0 Economizer Operation**

- 3.1 Enthalpy Sensor and Operation
- 3.2 Dry Bulb Sensor and Operation
- 3.3 Supply Air Sensor
- 3.4 Minimum Position

#### **4.0 Heating Operation AC / HP**

- 4.1 Electric Heat (AC systems)
- 4.2 Heat Pump Heating Operation
- 4.3 Defrost Operation (Heat Pumps)
- 4.4 Electric Heat / Outdoor Sensor / SCKT / EHDD (Heat Pumps)

#### **5.0 Dehumidification Operation AC / HP**

- 5.1 Hot Gas Reheat
- 5.2 Electric Reheat
- 5.3 Pulse Reheat

#### **6.0 Refrigeration Protection**

- 6.1 High Pressure lockout
- 6.2 Low Pressure Lockout / Freeze Protection
- 6.3 Loss of Charge / Flat Unit Fault
- 6.4 Freeze Sensor Protection
- 6.5 Anti Short Cycle

## 7.0 Additional Features

- 7.1 Modulating Head pressure Control (ECM Outdoor Motors)
- 7.2 Emergency Ventilation
- 7.3 Forced Cooling
- 7.4 Modbus Communications
- 7.5 Low Voltage (Brownout)

## 8.0 Smoke / Fire Shutdown

- 8.1 System Shutdown Contact Wiring

**Note:** Equipment, devices and necessary system components are specified in the respective section.

**Note:**

1. All inputs on the control board go through a 5 seconds Time-On Delay to prevent nuisance request. Compressor Outputs go through 5 seconds staggered Time On delay to prevent nuisance tripping of breaker due to the inrush associated with these large inductive loads.
2. Normal Operating Mode describes a mode in which there are no active faults which would interrupt the operation of the system.

### **1.0 Indoor Blower Operation**

The speed at which the indoor blower will operate is based on the discrete operational inputs that have 24vac applied. These inputs are listed below.

- 1.1 G Input** – A request for Fan Only (independent G-signal via Digital input or Modbus), results in the indoor motor turning “ON” and operating at the “G” motor speed (Only Applicable for EC motors).
- 1.2 Y1 Input** – A request for Y1 (independent Y1-signal via Digital input or Modbus), results in the indoor motor turning “ON” and operating at the “Y1” motor speed (Only Applicable for EC motors).
- 1.3 Y2 Input** – A request for Y2 (independent Y2-signal via Digital input or Modbus), results in the indoor motor turning “ON” and operating at the “Y2” motor speed (Only Applicable for EC motors).
- 1.4 W2 Input** – A request for W2 (independent W2-signal via Digital input or Modbus), results in the indoor motor turning “ON” and operating at the “W2” motor speed (Only Applicable for EC motors).
- 1.5 HUM Input** – A request for HUM (independent HUM-signal via Digital input or Modbus), results in the indoor motor turning “ON” and operating at the “HUM” motor speed (Only Applicable for EC motors).

When there is a request for Indoor Fan (G-input High) along with a request for cooling, heating or dehumidification, the G-Input becomes lowest priority. This means that in any combination involving the G-input, the speed associated to Fan Only will never take precedence.

The priority list from Highest to Lowest goes as follows:

1. Y2 - Request
2. Y1 - Request
3. W2 - Request
4. HUM - Request
5. G - Request

**Note:** The priority list above also describes the operation that takes precedence in

the event that there is a request for all operations or a combination of operations. The controller will NOT energize the compressor outputs and the heater output simultaneously if configured for AC. The controller WILL energize the compressor outputs and the heater output simultaneously if configured for HP.

The speed at which the Indoor Fan Operates during Stage 1 (Y1) and Stage 2 (Y2) Cooling Request can be set directly at the board using the configuration menu settings 4 and 5. All requests are interlocked with the Indoor Fan and will run the Fan at the respective speed associated with the operation. This means that a lone call for Stage 1 (Y1) Cooling will automatically run the Indoor Fan at Stage 1 (Y1) Cooling Speed even without a request for Indoor Fan. This holds true for all request.

## **2.0 Cooling Operation**

<b>AC Systems Request</b>	<b>Active Input</b>	<b>Active Output</b>
Stage 1 Cooling (Fixed Compressor)	Y1	CC1 (Partial Capacity)
Stage 1 Cooling (2 Fixed Compressors)	Y1 or Y2	CC1 or CC2 Respectively (Partial Capacity)
Stage 1 Cooling (1 Staged Compressor)	Y1	CC1 (Partial Capacity)
Stage 2 Cooling (2 Fixed Compressors)	Y1 + Y2	CC1 + CC2 (Full Capacity)
Stage 2 Cooling (2 Staged Compressors)	Y1 + Y2	CC1 + CC2 (Full Capacity)

**2.1 Mechanical Cooling (AC systems)** – This section will describe the sequence of operation which takes place during Direct Expansion (DX) cooling from a control standpoint.

**Note:** The system type must be configured for “AC” operation in setting 1 of the configuration menu of the control board for proper AC system operation. This system type is selected at the factory and there’s no need to change this setting.

**2.1.1Y1 Cooling (Partial Capacity 1st Stage)** – In normal operating mode, a request for “Stage1 Cooling” Y1-signal via Digital input or Modbus), energizes Compressor 1 Relay Output (CC1) on the PCB. The controller provides a continuous control signal associated to the Indoor Fan Motor, that is proportional to the “Y1” speed setting on the board or via Modbus. It also outputs a request dependent (based on FCC IN) control signal for the Outdoor Fan Motor (Only applicable to ECM motors). In Stage 1 Cooling operation, the compressor operates at partial capacity and the indoor fan remains on continuously but the outdoor fan modulates based on liquid line temperature. The Fan Cycle Control Sensor (Low Ambient Control Sensor) monitors the liquid line to maintain a 90F liquid line temperature. When the liquid line temperature is below 80F the outdoor fan will shut off. A liquid line temperature above 115F will force the outdoor fan to operate at the maximum speed set on the control board for setting 7 in the configuration menu. The outdoor fan will speed up and slow down between liquid line temperature of 80F and 115F. Systems with (PSC Outdoor Motors) utilizes a Fan Cycle Switch which closes at 400 PSIG to energize the OFR (outdoor fan relay) to start the outdoor fan which runs until the switch reopens (at 290 PSIG). These outputs function as described until the Cooling setpoint is satisfied. This is considered as ON/OFF fan cycle control and the PSC motor will not modulate.

**Note:** Single Stage compressors operate at full capacity upon a request for Y1.

**2.1.2Y1 and Y2 Cooling (Full Capacity 2nd Stage)** – If the space temperature continues to increase pass the defined differential, Stage 2 Cooling (Y2-input) is energized. Under normal operation, this energizes the Compressor 2 Output (CC2). The Indoor Fan motor, will operate at “Y2” speed instead of “Y1” speed since Y2 has higher priority. These outputs remain energized until the cooling setpoint is satisfied. Once the setpoint is satisfied, the Compressor and the Outdoor fan outputs are de-energized. The Indoor motor continues to run based on the fan purge timer setpoint (default 90 seconds) selected in setting 3 of the configuration menu of the control board.

**Note:** 2 Stage compressors require a request for Y2 to operate at full capacity in Cooling operation. All Air-conditioners and Heat Pump systems with 2 stage compressors are allowed 2 stage cooling operation.

**2.2 Mechanical Cooling (HP systems)** – This section will describe the sequence of operation which takes place during Direct Expansion (DX) cooling from a control standpoint. The reversing valve (O Input) must be energized for Cooling operation on Heat Pump systems.

**Note:** The system type must be configured for “HP” operation in setting 1 of the configuration menu of the control board for proper HP system operation. This system type is selected at the factory and there’s no need to change this setting.

**2.2.1Y1+ O Cooling (Partial Capacity 1st Stage)** – In normal operating mode, a request for “Stage1 Cooling” Y1 + O signal via Digital input or Modbus), energizes the Reversing Valve Output (RV) and Compressor 1 Relay Output (CC1) on the PCB. The controller provides a continuous control signal associated to the Indoor Fan Motor, that is proportional to the “Y1” speed setting on the board or via Modbus. It also outputs a request dependent (based on FCC IN) control signal for the Outdoor Fan Motor (Only applicable to ECM motors). In Stage 1 Cooling operation, the compressor operates at partial capacity and the indoor fan remains on continuously but the outdoor fan modulates based on liquid line temperature. The Fan Cycle Control Sensor (Low Ambient Control Sensor) monitors the liquid line to maintain a 90F liquid line temperature. When the liquid line temperature is below 80F the outdoor fan will shut off. A liquid line temperature above 115F will force the outdoor fan to operate at the maximum speed set on the control board for setting 7 in the configuration menu. The outdoor fan will speed up and slow down between liquid line temperature of 80F and 115F. Systems with (PSC Outdoor Motors) utilizes a Fan Cycle Switch which closes at 400 PSIG to energize the OFR (outdoor fan relay) to start the outdoor fan which runs until the switch reopens (at 290 PSIG). These outputs function as described until the Cooling setpoint is satisfied. This is considered as ON/OFF fan cycle control and the PSC motor will not modulate.

**Note:** Single Stage compressors operate at full capacity upon a request for Y1.

**2.2.2Y1 + Y2 + O Cooling (Full Capacity 2nd Stage)** – If the space temperature continues to increase pass the defined differential, Stage 2 Cooling (Y1+Y2+O input) is energized. Under normal operation, this energizes the Compressor 2 Output (CC2). The Indoor Fan motor, will operate at “Y2” speed instead of

“Y1” speed since Y2 has higher priority. These outputs remain energized until the cooling setpoint is satisfied. Once the setpoint is satisfied, the Compressor and the Outdoor fan outputs are de-energized. The Indoor motor continues to run based on the fan purge timer setpoint (default 90 seconds) selected in setting 3 of the configuration menu of the control board.

**Note:** 2 Stage compressors require a request for Y2 to operate at full capacity in Cooling operation. All Air-conditioners and Heat Pump systems with 2 stage compressors are allowed 2 stage cooling operation.

**Note:** With staged compressors, a CC2 output without a CC1 output will neither result in partial capacity nor full capacity. Only CC1 output can achieve partial capacity. Both CC1 and CC2 outputs are required to achieve full capacity.

### 3.0 Economizer Operation (If Equipped)

#### Damper Actuator

The damper actuator is a 24V motor that modulates the position of the damper blade. It is capable of driving a full 90 degrees within 90 seconds. The assembly has a spring return to close the damper during power outage.

**3.1 Enthalpy Sensor and Operation** – The enthalpy sensor responds to the total heat content of the outdoor air to provide the changeover to outside air for free cooling. The control board must be configured for proper operation of the economizer by selecting Y= Yes in the configuration menu setting 12. The sensor type must be selected in setting 13 for EN=Enthalpy. The desired changeover setpoint must be selected in setting 14 (default D=63F@50% rh). Example of Enthalpy Sensor and Enthalpy curve is shown below.

**Note:** Selecting N=No in configuration setting 12 will disable economizer operation.

**⚠ DANGER**

**SEVERE HAZARD. THE ECONOMIZER CONTAINS MOVING PARTS CAPABLE OF CAUSING SERIOUS INJURY OR DEATH. DISCONNECT POWER BEFORE REMOVING THE COVERING PANEL.**

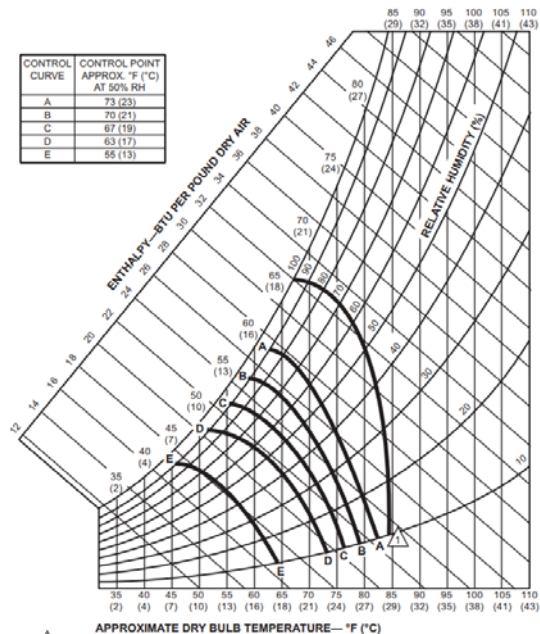


Enthalpy Setpoint is Setting 14 in control board configuration menu.

Options

- A= 73°F
- B= 70°F
- C= 67°F
- D= 63°F
- E= 55°F

All settings are @ 50%Rh



**Figure 12. Enthalpy Sensor & Temperature Control Points**



### **Enthalpy Operation**

On a call for cooling from the wall-mounted thermostat, if outdoor conditions are suitable, the sensor will open the damper and admit outside air (i.e., economizer free cooling). If the outdoor ambient is too hot or humid (enthalpy sensor only), the sensor will place the actuator in the closed or minimum open position and activate mechanical cooling. The compressor is locked-out during the economizer cooling mode. The Supply Air sensor monitors the supply air of the system in economizer mode to modulate the economizer damper to maintain a 55F supply air temperature. During the testing of the air conditioner at the factory, the control board has been configured for the sensor type used in the system. There should be no need to change the sensor configuration. If an enthalpy sensor is being used, setting 13 of the control board configuration menu will be set for EN= Enthalpy. A disconnected or faulty enthalpy sensor is annunciated on the control board display as “ES-F”. Economizer operation is only allowed in Cooling Mode.

**Note:** A call for Y2 or FC Inputs or a faulty or disconnected enthalpy sensor will override the economizer operation and force the compressor to operate.

**3.2 Dry Bulb Sensor and Operation** – The dry bulb sensor only responds to the dry bulb temperature of the outside air and ignores the humidity. The sensor is a 10K NTC sensor probe. The factory setting is 63°F. This setpoint can be adjusted in 1F increments from 20F to 105F in the control board configuration menu setting 14. Example of the dry bulb sensor is shown below.

**Note:** Selecting N=No in configuration setting 12 will disable economizer operation.



**Figure 13. Dry Bulb Sensor**

On a call for cooling from the wall-mounted thermostat, if outdoor conditions are suitable, the sensor will open the damper and admit outside air (i.e., economizer free cooling). If the outdoor ambient is too hot (dry bulb sensor only), the sensor will place the actuator in the closed or minimum open position and activate mechanical cooling. The compressor is locked-out during the economizer cooling mode. The Supply Air sensor monitors the supply air of the system in economizer mode to modulate the economizer damper to maintain a 55F supply air temperature.

During the testing of the air conditioner at the factory, the control board has been configured for the sensor type used in the system. There should be no need to change the sensor configuration. If a dry bulb sensor is being used, setting 13 of the control board configuration menu will be set for

DB=Dry Bulb. A disconnected or faulty dry bulb sensor is annunciated on the control board display as “db-F”. Economizer operation is only allowed in Cooling Mode.

**Note:** A call for Y2 or FC Inputs or a faulty or disconnected dry bulb sensor will override the economizer operation and force the compressor to operate.

**3.3 Supply Air Sensor** – The supply air sensor is a 10K NTC sensor probe mounted on a bracket in the supply air opening of the system. The probe senses the air temperature entering the structure, and provides a signal to the economizer controller for modulating the position of the damper. The default supply air temperature is 55F in economizer cooling and is not adjustable. A disconnected or faulty supply air sensor is annunciated on the control board display as “AS-F”.

**Note:** A faulty or disconnected supply air sensor will override the economizer operation and force the compressor to operate.

**3.4 Minimum Position** – The minimum position controls the amount of outside air introduced in the building when not in economizer operation or to meet a minimum outside air requirement to keep the damper open. This feature is only applicable to systems with economizer or ventilation damper options. The minimum position can be adjusted in the control board configuration menu with setting 15. The setpoint adjustments are from 20 (2vdc) to 100 (10vdc) in 1vdc increments. This is an independent adjustment and can be set to drive the ventilation damper open to any position from closed to fully opened. A selection of 20 (2vdc) is the same as being set to OFF or fully closed.

#### **4.0 Heating Operation**

**4.1 Electric Heat (AC Systems with Electric Heat)** – When there is a request for “Electric Heat” (W2-signal via Digital input or Modbus), the system will run the Indoor Motor for 10 seconds prior to energizing the Heater Output. The Indoor Motor will operate at the “W2” speed setting on the board or via Modbus. Once the Heater output is energized, the Heater comes on at full capacity (no staging). The Heater will remain on until the Heating setpoint is satisfied and the request is dropped. Once the heating setpoint is satisfied, the Indoor motor continues to run based on the fan purge timer setpoint (default 90 seconds) selected in setting 3 of the configuration menu of the control board.

**Note:** A request for Cooling and Heating at the same time is not allowed and control board will not allow the electric heat to operate.

**4.2 Heat Pump Heating Operation** – This section will describe the sequence of operation which takes place during Direct Expansion (DX) heating from a control standpoint. The reversing valve (O Input) must NOT be energized for Heating operation on Heat Pump systems.

**Note:** The system type must be configured for “HP” operation in setting 1 of the configuration menu of the control board for proper HP system operation. This system type is selected at the factory and there’s no need to change this setting.

In normal operating mode, a request for “Heat Pump Heating” Y1 signal via Digital input or Modbus), energizes the Compressor 1 and 2 Relay Output (CC1+CC2) on the PCB. The controller provides a continuous control signal associated to the Indoor Fan Motor, that is proportional to the “Y2” speed setting on the board or via Modbus. The system is defaulted to operate at Full capacity in heat pump heating mode. It also outputs a request for the Outdoor Fan to operate at the max speed. In heat pump Heating operation, the compressor operates at Full capacity and the indoor and outdoor fans remain on continuously. The outdoor fan does not modulate in heat pump heat mode.

**4.3 Defrost Operation (Heat Pump Systems Only)** – The board has an integral accumulation run timer that runs on every request for heat pump heating. The system has a Defrost Sensor (DS) that monitors the outdoor coil circuit for freezing conditions. If the defrost sensor registers a temperature of 32°F while in the heat pump heating mode, it will initiate a defrost cycle based on the time selected in the control board configuration menu setting 8. The defrost time intervals selections are 30, 60 and 90 minutes and the factory default setting is 30 minutes. If the defrost sensor is still calling for defrost at the end of this delay, it will de-energize the outdoor fan, energize the reversing valve through the RV terminal, and keep the compressor energized. The defrost cycle will terminate on time or temperature. It will have a maximum defrost run time of 10 minutes, however, if the defrost sensor registers a temperature of 70°F or higher before the 10-minute maximum run time, the defrost cycle will terminate. If the defrost cycle has not completed (DS sensor above 70F) due the heating call being satisfied, the defrost cycle will continue upon the next call for heat pump heating to complete the defrost cycle. If freezing conditions are not present at the end of the defrost interval timer, the system will not perform a defrost cycle.

**Note:** If the DS sensor is disconnected or faulty, the compressor will not operate in heat pump heating mode and the control board display will annunciate the fault as “DS-F”.

**Note:** If “Yes” has been selected for Electric Heat During Defrost (EHDD) and “No” selected for the SCKT, the electric heat (EH) output will be energized during a defrost cycle to supply heat while the coil defrosts. *If the ODS is used, the electric heat will operate only if the outdoor temperature is below the ODS setpoint.*

**4.4 Electric Heat / Outdoor Sensor / SCKT / EHDD (Heat Pumps) – Electric Heat (HP systems with electric heat)**– When there is a request for “Electric Heat” (W2-signal via Digital input or Modbus), the system will run the Indoor Motor for 10 seconds prior to energizing the Heater Output. The Indoor Motor will operate at the “W2” speed setting on the board or via Modbus. Once the Heater output is energized, the Heater comes on at full capacity (no staging). The Heater will remain on until the Heating setpoint is satisfied and the request is dropped. Once the heating setpoint is satisfied, the Indoor motor continues to run based on the fan purge timer setpoint (default 90 seconds) selected in setting 3 of the configuration menu of the control board.

When the system is operating in Heat Pump mode the electric heat is considered as supplemental heat and will only be allowed under certain conditions due to additional features that may be used. These features include the Outdoor Sensor and SCKT (safety circuit). See ODS and SCKT for more details.

#### **ODS - Outdoor Sensor (Heat-Pumps Only)**

The outdoor sensor only responds to the temperature of the outside air. The sensor is a 10K NTC sensor probe. The factory setting is 50°F. This setpoint can be adjusted in 1F increments from 0F to 70F in the control board configuration menu setting 11. If the optional Outdoor Sensor is used (Heat-pump systems only). The electric heat will not operate upon a request for “W2” unless the outdoor temperature is below the setpoint for the ODS setpoint. If the sensor is not connected or faulty the electric heat will be allowed to operate anytime a request for W2 is present.

**Note:** A request for Cooling and Electric Heat at the same time is not allowed and the control board will not allow the electric heat to operate.

### **SCKT – Safety Circuit (Heat-Pumps Only)**

The SCKT is a selectable menu option in the control board configuration menu setting 10. The options for this feature are Y=Yes or N=No. When set to Y=Yes, control board will prevent the compressor and electric heat from operating simultaneously. In this case the compressor will shut off upon a request for “W2” (Electric Heat). The compressor will remain off as long as the request for W2 is active. Once the request for W2 satisfies the compressor will be allowed to operate. The default setting for SCKT is N=No, the electric heat and compressor will be allowed simultaneous operation in the heat pump heating mode.

**Note:** If the ODS is used the electric heat will not operate unless the outdoor temperature is below the ODS setpoint.

### **EHDD – Electric Heat During Defrost (Heat-Pumps Only)**

The EHDD is a selectable menu option in the control board configuration menu setting 9. The options for this feature are Y=Yes or N=No. When set to Y=Yes, control board will force the electric heat to operate during a defrost cycle unless SCKT is set to Y=Yes or the outdoor temperature is not below ODS (if equipped) setpoint. The default setting for EHDD is Y=Yes.

**Note:** SCKT takes priority over ODS and EHDD.

## **5.0 Dehumidification Operation AC / HP**

**5.1 Hot Gas Reheat (if equipped) –** When there is a request for “Dehumidification” (HUM-signal via Digital input or Modbus), this will result in the control board energizing the Indoor Fan (IBR), Compressor 1 (CC1), Compressor 2 (CC2), Reversing Valve (RV) “heat pumps only” and the Reheat (RH) relay outputs on the board. This forces the system to operate in the full capacity cooling mode while energizing the reheat solenoid valve to allow hot gas to be introduced into the supply air stream of the system for dehumidification operation. The indoor fan motor will operate at the “Dehum” speed setting on the board or via Modbus. The indoor fan remains on continuously but the outdoor fan modulates based on liquid line temperature. The Fan Cycle Control Sensor (Low Ambient Control Sensor) monitors the liquid line to maintain a 90F liquid line temperature. When the liquid line temperature is below 80F the outdoor fan will shut off. A liquid line temperature above 115F will force the outdoor fan to operate at the maximum speed set on the control board for setting 7 in the configuration menu. The outdoor fan will speed up and slow down between liquid line temperature of 80F and 115F. Systems with (PSC Outdoor Motors) utilizes a Fan Cycle Switch which closes at 400 PSIG to energize the OFR (outdoor fan relay) to start the outdoor fan which runs until the switch reopens (at 290 PSIG). These outputs function as described until the Dehumidification setpoint is satisfied. This is considered as ON/OFF fan cycle control and the PSC motor will not modulate.

**Note:** A request for Y1 or Y2 via digital input or Modbus takes priority over dehumidification operation and the hot gas reheat valve will de-energize.

**5.2 Electric Reheat (if equipped) –** When there is a request for “Dehumidification” (HUM-signal via Digital input or Modbus), this will result in the control board energizing the Indoor Fan (IBR), Compressor 1 (CC1), Compressor 2 (CC2), Reversing Valve (RV) “heat pumps only” and the Reheat (RH) relay outputs on the board. This forces the system to operate in the full capacity cooling mode while energizing the

electric heat to allow heat to be introduced into the supply air stream of the system for dehumidification operation. The indoor fan motor will operate at the “Dehum” speed setting on the board or via Modbus. The indoor fan remains on continuously but the outdoor fan modulates based on liquid line temperature. The Fan Cycle Control Sensor (Low Ambient Control Sensor) monitors the liquid line to maintain a 90F liquid line temperature. When the liquid line temperature is below 80F the outdoor fan will shut off. A liquid line temperature above 115F will force the outdoor fan to operate at the maximum speed set on the control board for setting 7 in the configuration menu. The outdoor fan will speed up and slow down between liquid line temperature of 80F and 115F. Systems with (PSC Outdoor Motors) utilizes a Fan Cycle Switch which closes at 400 PSIG to energize the OFR (outdoor fan relay) to start the outdoor fan which runs until the switch reopens (at 290 PSIG). These outputs function as described until the Dehumidification setpoint is satisfied. This is considered as ON/OFF fan cycle control and the PSC motor will not modulate.

**Note:** A request for Y1 or Y2 via digital input or Modbus takes priority over dehumidification operation and the electric heat will de-energize.

**5.3 Pulse Reheat / Dehum Supply Set** – The Pulse reheat feature allows for supply air temperature limiting dehumidification control. When setting 18 is set to Y in the configuration menu the RH output of the control board will energize and de-energized based on the dehumidification supply air temperature setpoint in setting 19 of the configuration menu. During dehumidification operation the RH output is energized and the supply air is monitored to allow the supply air to reach the dehumidification supply air setpoint. When the setpoint is reached, the RH output is de-energized and the system will operate in cooling mode until the supply air temperature drops 5°F. When the 5°F differential has been met the RH output will energize and dehumidification operation will resume. When setting 18 is set to N= No, Pulse Reheat is not active and the supply air will not be monitored to limit supply air temperature in the dehumidification mode. The Pulse Reheat and Dehum Supply Set may also be selected and adjusted via MODBUS.

## **6.0 Refrigeration Protection**

**6.1 High Pressure Lockout** – This condition describes the abnormal rise in Head Pressure within system with an acceptable limit of 660 PSI (+/-20PSI). The fault will only be active when the High-Pressure Switch (Normally Closed) opens during a request for Cooling or Heat Pump Heating. The first time this fault condition occurs, the system cuts the compressor off WITHOUT locking out. Once the pressure normalizes (drops below 450 PSI), the system will resume operation if the cooling or heat pump heating call still exist. If this fault occurs a second time on the same Cooling or Heat pump heating request, the system locks out. Lockouts can be monitored using the control board display for the current fault. The fault for a high-pressure lockout will displayed as “*HP-Lc*”. The faults can also be monitored via MODBUS by reading the respective value based on the MODBUS map that is provided. After this lockout condition is reached, the cooling/heat pump heating call must be cycled (on/off of respective request) or the system must be power cycled to clear the fault. The system will continue to lockout until the problem is rectified.

**6.2 Low Pressure Lockout** – This condition describes the abnormal drop in Suction Pressure within system with an acceptable limit of 75 PSI (+/-20PSI). The fault will

only be active when the Low-Pressure Switch (Normally Closed) opens during a request for Cooling. The first time this fault condition occurs, the system cuts the compressor off WITHOUT locking out. Once the pressure normalizes (rises above 105 PSI), the system will resume operation if the cooling call still exist. If this fault occurs a second time on the same Cooling request, the system locks out. Lockouts can be monitored using the control board display for the current fault. The fault for a high-pressure lockout will displayed as “*HP-Lc*”. The faults can also be monitored via MODBUS by reading the respective value based on the MODBUS map that is provided. After this lockout condition is reached, the cooling call must be cycled (on/off of respective request) or the system must be power cycled to clear the fault. For a 2-compressor system, each lockout is isolated to the respective circuit and will not interfere with the operation of the other circuit providing that the circuits operate independently. The system will continue to lockout until the problem is rectified.

**Note:** The Low-pressure switch is ignored in heat-pump and de-humidification operation. The loss of charge switch is monitored in all modes of compressor operation.

**6.3 Loss of Charge / Flat Unit** – This condition describes the abnormal drop in Suction Pressure within system with an acceptable limit of 40 PSI (+/-20PSI). The fault will only be active when the Loss of Charge Switch (Normally Closed) opens during compressor operation. The first time this fault condition occurs, the system cuts the compressor off WITHOUT locking out. Once the pressure normalizes (rises above 60 PSI), the system will resume operation if the cooling call still exist. If this fault occurs a second time on the same Cooling request, the system locks out. Lockouts can be monitored using the control board display for the current fault. The fault for a high-pressure lockout will displayed as “*HP-Lc*”. The faults can also be monitored via MODBUS by reading the respective value based on the MODBUS map that is provided. After this lockout condition is reached, the cooling call must be cycled (on/off of respective request) or the system must be power cycled to clear the fault. For a 2-compressor system, each lockout is isolated to the respective circuit and will not interfere with the operation of the other circuit providing that the circuits operate independently. The system will continue to lockout until the problem is rectified.

**Note:** Loss of Charge and Low-pressure switches are used on Heat Pump systems. Air-conditioning systems use the Low-pressure switch for both low-pressure and loss of charge faults.

**6.4 Freeze Sensor Protection** – A10K Nominal NTC Thermistor is connected to the “LPS 1 input with the sensor secured to the evaporator feeder tubes to monitor for freezing conditions while in cooling operation. The sensor is ignored for the first 15 minutes of compressor operation and after this time if the sensor reads 25F or less the compressor will shut down. The control board will display an “FS” fault and compressor will remain off for a minimum of 3 minutes. The sensor must reach a temperature of 55F in addition to the 3-minute minimum off timer. After the timer and reset temperature has been met the compressor is allowed to operate in normal operation.

**Note:** A freeze fault does not initiate and hard lockout condition. A freeze fault only interrupts the compressor cooling operation temporarily. The freeze sensor input is ignored if the sensor is not connected to the control board input.

**6.5 Anti-Short Cycle** – This is a built-in protection mechanism that increases the reliability of the compressor by protecting it from excessive short cycling. When the compressor goes off, due to any fault, emergency or if the cooling / heat pump heating setpoint is satisfied, a built-in 3-minute timer locks the compressor for that respective circuit out. This can be monitored and adjusted via MODBUS by referencing the appropriate register. However, it can only be monitored at the board level by waiting for the 3 minutes to elapse.

## **7.0 Additional Features**

**7.1 Modulating Head Pressure Control (ECM Outdoor Motors)**– A10K Nominal NTC Thermistor is connected to the “FCC1” and “FCC2” inputs for circuit 1 and circuit 2 respectively. The sensor is secured to the liquid line of the system to monitor the liquid line temperature. When this sensor is connected, the thermistor value is used as the process variable when controlling the head pressure. The controller modulates the Outdoor Fan Motor to maintain a 90°F temperature setpoint. The controller will always use the greater value of FCC1 and FCC2 input as the reference point. In the event that the Thermistor is disconnected, the controller reverts to the outdoor fan operating at the max speed setting selected on the control board configuration menu setting 7.

**Note:** Systems with PSC outdoor motors utilize a fan cycle switch in the refrigeration circuit for on/off fan cycle head pressure control.

### **PSC Motor Head Pressure Control**

The onboard outdoor fan relay (OFR) is used to control the Fan Cycle Switch based on CC output to the Compressor. Once the compressor out (CC1) is energized the OFR output will also be energized and the fan cycle switch will cycle on and off at 290psi and 400psi. This will turn the Outdoor Fan Motor on and off to maintain the head-pressure of the system, the OFR output is only used on systems with PSC out door motor and Fan Cycle Switch (FCC) only.

**7.2 Emergency Ventilation (Motorized Damper or Economizer Equipped Systems)** – When there is a request for “Emergency Ventilation” (EV-signal via Digital input or Modbus), the system will run the Indoor Motor at the “Y2” speed setting on the board or via Modbus and provide a 10vdc signal from the ECO output of the control board to drive the motorized damper fully open.

**Note:** The compressor and electric heat WILL NOT operate while in the emergency ventilation mode.

**7.3 Forced Cooling (economizer equipped systems)** – During economizer cooling, if a request for “Forced Cooling” (FC-signal via Digital input or Modbus) is present. The control board will force the economizer to close and start the compressor to operate at full capacity cooling. This is considered an override of the economizer in the event economizer cooling can’t keep up with the cooling demand in economizer mode. The Indoor Motor at the “Y2” speed setting on the board or via Modbus and the system will operate in normal cooling mode until the request for FC is satisfied. Once satisfied the system will be allowed to return to economizer operation if conditions are favorable.

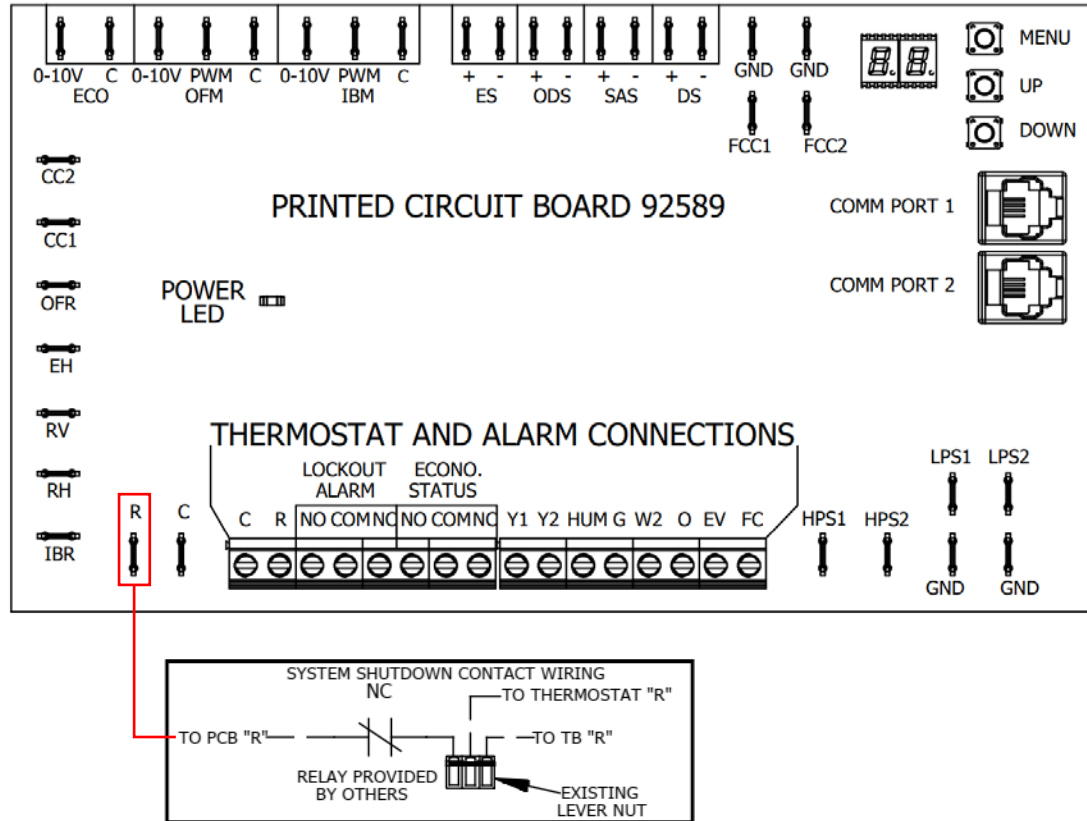
**7.4 Low Voltage (Brownout)** – The control board monitors the 24 VAC power supply for low voltage protection. When the power supply voltage is 16 VAC or less for 10

seconds the control board will de-energize all outputs. This is considered a voltage brownout (low voltage) condition and the display of the control board will show “03” as an indicator of brownout (low voltage). When the voltage rises back to 17 VAC, the control board will allow the system to operate.

**Note:** The nominal power supply for the control board is 24VAC and this voltage should be confirmed during startup to assure normal operation.

## 8.0 Smoke / Fire Shutdown

**8.1 System Shutdown Contact Wiring –** Add Normally Closed Dry contacts as shown for immediate shutdown of HVAC upon contacts opening.





## Chapter 6: Scholar QR Startup

### 6.1 START-UP PROCEDURE

#### CAUTION

**THIS UNIT CONTAINS A CRANKCASE HEATER (CCH). FAILURE TO FOLLOW INSTRUCTIONS REGARDING THE CCH AND STARTUP WILL VOID THE MANUFACTURER'S WARRANTY.**

***Note for Scholar QR units manufactured after 12/05/2022:***

Crankcase heaters (CCH) help to prevent refrigerant migration in the off cycle of the compressor, which prevents oil dilution in the compressor. In transport and install, the compressor could become a location in which refrigerant migrates to. An updated PLC program for Marvair Scholar QR (VDH) will now feature the timer function for the crankcase heater. This timer function will prevent the compressor from operating while the crankcase heater operates for 24 hours on power up.

On initial power-up, the timer will activate. During the CCH timing function, any disruption in power will cause the timer to restart. No compressor operation will be allowed during this period. However, the indoor blower (g), ventilation (gwr) & electric heat (w2) will be allowed to function. A timer is displayed on the main screen beside the "Marvair" logo which shows the remainder of the duration of the compressor lockout process. Once the timer has elapsed, the function will terminate and the compressor will be allowed to operate. This is a one-time operational feature. That is, once the CCH timer has elapsed, the compressor would not lockout again (based on this feature), irrespective of a power cycle. In the future, if there is a need to reprogram the unit that is already installed, this will activate the timer again. For run-test, there is a hidden button that was implemented to bypass the timer and lock it in place. This hidden feature is solely for Marvair personnel only and should only be passed on to the personnel who is doing the PLC re-programming or run testing of the unit.

#### **IMPORTANT**

**THIS UNIT CONTAINS BALL-TYPE SHUT-OFF VALVES IN THE SUCTION LINE AND DISCHARGE LINE AT THE COMPRESSOR.**

**THE VALVES ARE SHIPPED FROM THE FACTORY IN THE CLOSED POSITION.**

**THE VALVES MUST REMAIN CLOSED UNTIL THE UNIT IS INSTALLED IN ITS PERMANENT UPRIGHT POSITION.**

**POWER MUST BE ON FOR AT LEAST 24 HOURS PRIOR TO OPERATING THE COMPRESSOR TO ALLOW PRE-HEATING FROM THE COMPRESSOR CRANKCASE HEATER. THE VALVES MUST BE OPENED AT THE SAME TIME THE CRANKCASE HEATER IS ENERGIZED FOR LIQUID REFRIGERANT TO BE EVAPORATED AND DRIVEN FROM THE COMPRESSOR CRANKCASE.**

**THE VALVES MUST BE OPENED PRIOR TO FULL OPERATION.**

**DO NOT OPERATE THE COMPRESSOR WITH THESE VALVES CLOSED. THIS WILL VOID THE FACTORY WARRANTY.**

**REFER TO THE PRODUCT I/O MANUAL FOR MORE DETAILS.**

**REFER TO THE WARNING LABEL ON THE COMPRESSOR PLUG. THE COMPRESSOR WILL NOT RUN WITHOUT CONNECTING THE PLUG.**

**⚠ CAUTION**

**FAILURE TO COMPLY COULD RESULT IN DAMAGE TO THE UNIT.**

- 1. THIS SYSTEM HAS A MULTI-TAP CONTROL TRANSFORMER. REFER TO THE WIRING DIAGRAM ON THE UNIT AND THIS MANUAL FOR THE CORRECT TAP TO USE FOR YOUR INPUT VOLTAGE. FAILURE TO ENSURE THE PROPER PRIMARY VOLTAGE TRANSFORMER CONNECTIONS MAY RESULT IN PREMATURE COMPONENT FAILURE AND NUISANCE TRIPS.**
- 2. SOME COMPRESSORS HAVE A CRANKCASE HEATER. FOR UNITS WITH CRANKCASE HEATERS, POWER MUST BE ON FOR AT LEAST 24 HOURS BEFORE OPERATING THE COMPRESSOR. WARRANTY WILL BE VOID IF NOT FOLLOWED.**
- 3. FOR UNITS WITH SCROLL COMPRESSORS AND A 3Ø POWER SUPPLY, IT IS IMPERATIVE THAT THE COMPRESSOR ROTATE IN THE PROPER DIRECTION. REFER TO THE SECTION 1.12 OF THIS MANUAL TO VERIFY PROPER ROTATION.**

A. On SCHOLAR QR models with two stage compressors, only the cooling mode operates in two stages. Mechanical heating (compressor) is a single stage as is the dehumidification mode.

1. Turn the disconnect in the Scholar QR unit to “OFF” position and double check all electrical connections before applying power.
2. Set the remote thermostat system switch to “OFF” position. The blower switch should be in “AUTO” position.
3. Check the voltage supply to the disconnect. If voltage readings are appropriate, proceed with start-up. (See Figure 13 for acceptable voltage ranges.) If voltage readings are not appropriate, check the power leads at the disconnect and the main breaker in the mechanical room. Take appropriate corrective action to supply sufficient voltage to the Scholar QR disconnect.

Electrical Rating Designations*	A	C	D
Nominal Voltage	208/230	208/230	460
Phase	1	3	3
Minimum Voltage	197	197	414
Maximum Voltage	253	253	506

\* Letters refer to model number code designations.

Example: VDH2036H① — Voltage

**Table 4. Voltage Limitations**

4. Turn the Scholar QR heat pump disconnect to “ON” position.
5. Please refer to the thermostat instructions for configuration and start-up of units with 2-stage compressors.
  - a) Check to see that when the heat pump comes on that the air coming out the discharge grille is cooling. Let unit run for five minutes in this mode. If heat pump continues to run and provide cooling, this verifies that the indoor blower, compressor and outdoor blower are all running.
  - b) Now slowly raise the cooling set point up toward room temperature until the pump compressor and outdoor blower motor turn off. This will be audible. The indoor blower will continue to run and turn off after 90 seconds.

**6. Heating (heat pump version only)** (Note: Models SCHOLAR QR with 2-stage compressors only have one stage of heating.)

- a) Put the thermostat system switch to “Heat” mode. Wait five minutes after testing on cooling, before testing in heating mode.
- b) Slowly raise the heating set point above room temperature until the heat pump comes on. The indoor blowers will start and the heat pump will provide warm air from the air supply grille. Let run for five minutes.
- c) Slowly lower the set point temperature until the heat pump compressor and outdoor blower turn off. The indoor blower will turn off 90 seconds later.

**7. Heating (air conditioner version only)**

- a) Set the heating set point below room temperature and put the thermostat system switch on “Ht.”
- b) Raise the set point slowly and the indoor blower and the electric supplemental heat will turn on at the same time.
- c) Lowering the set point slowly should turn the electric heat off. The indoor blower will turn off 90 seconds later.

**8. Automatic Changeover**

For an automatic changeover remote thermostat, the proper functioning of the system can be checked for cooling and heating by using the same sequence as detailed above with the thermostat system switch put in “AUTO” position.

**9. Emergency Heat (heat pump version only)**

This setting on a remote thermostat is to provide electric heat in the event the compressor does not function, and heat is required. In emergency heat mode, the compressor is de-energized and electric heat supplies all heating, controlled by the thermostat.

To check this out, set the heating set point below room temperature and put the thermostat system switch on “Em. Ht.”

Raise the set point slowly and the indoor blower and the electric supplemental heat will turn on at the same time.

Lowering the set point slowly should turn the electric heat off. The indoor blower will turn off 90 seconds later.

## **Chapter 7: Service and Charging/Recovery**

### **7.1 SAFETY PRECAUTIONS**

#### **SERVICE**

Prior to beginning work on systems containing FLAMMABLE REFRIGERANTS, safety checks are necessary to ensure that the risk of ignition is minimized. For repair to the REFRIGERATING SYSTEM, the following shall be completed prior to conducting work on the system.

1. Work shall be undertaken under a controlled procedure to minimize the risk of flammable gas or vapor being present while the work is being performed.
2. All maintenance staff and others working in the local area shall be instructed on the nature of work being carried out. Work in confined spaces shall be avoided.
3. The area shall be checked with an appropriate refrigerant detector prior to and during work, to ensure the technician is aware of potentially toxic or flammable atmospheres. Ensure that the leak detection.
4. If any hot work is to be conducted on the refrigerating equipment or any associated parts, appropriate fire extinguishing equipment shall be available to hand. Have a dry powder or CO2 fire extinguisher adjacent to the charging area.
5. No person carrying out work in relation to a REFRIGERATING SYSTEM which involves exposing any pipe work shall use any sources of ignition in such a manner that it may lead to the risk of fire or explosion. All possible ignition sources, including cigarette smoking, should be kept sufficiently far away from the site of installation, repairing, removing and disposal, during which refrigerant can possibly be released to the surrounding space. Prior to work taking place, the area around the equipment is to be surveyed to make sure that there are no flammable hazards or ignition risks. "No Smoking" signs shall be displayed.
6. Ensure that the area is open or that it is adequately ventilated before breaking into the system or conducting any hot work. A degree of ventilation shall continue during the period that the work is carried out. The ventilation should safely disperse any released refrigerant and preferably expel it externally into the atmosphere.
7. The minimum test pressure for the low side of the system shall be the low side design pressure and the minimum test pressure for the high side of the system shall be the high side design pressure, unless the high side of the system, cannot be isolated from the low side of the system in which case the entire system shall be pressure tested to the low side design pressure.

### **7.2 LEAK DETECTION**

Under no circumstances shall potential sources of ignition be used in the searching for or detection of refrigerant leaks. A halide torch (or any other detector using a naked flame) shall not be used. The following leak detection methods are deemed acceptable for all refrigerant systems. Electronic leak detectors may be used to detect refrigerant leaks but, in the case of FLAMMABLE REFRIGERANTS, the sensitivity may not be adequate, or may need re-calibration. (Detection equipment shall be calibrated in a refrigerant-free area.) Ensure that the detector is not a potential source of ignition and is suitable for the refrigerant used. Leak detection equipment shall be set at a percentage of the LFL of the refrigerant and shall be calibrated to the refrigerant employed, and the appropriate percentage of gas (25 % maximum) is confirmed. Leak detection fluids are

also suitable for use with most refrigerants but the use of detergents containing chlorine shall be avoided as the chlorine may react with the refrigerant and corrode the copper pipework. **Note:** Examples of leak detection fluids are

1. Bubble method
2. Fluorescent method agents

If a leak is suspected, all naked flames shall be removed/extinguished. If a leakage of refrigerant is found which requires brazing, all of the refrigerant shall be recovered from the system, or isolated (by means of shut off valves) in a part of the system remote from the leak.

### 7.3 CHARGING PROCEDURES

In addition to conventional charging procedures, the following requirements shall be followed.

1. Ensure that contamination of different refrigerants does not occur when using charging equipment. Hoses or lines shall be as short as possible to minimize the amount of refrigerant contained in them.
2. Cylinders shall be kept in an appropriate position according to the instructions.
3. Ensure that the REFRIGERATING SYSTEM is earthed prior to charging the system with refrigerant.
4. Label the system when charging is complete (if not already).
5. Extreme care shall be taken not to overfill the REFRIGERATING SYSTEM.
6. Prior to recharging the system, it shall be pressure-tested with the appropriate purging gas. The system shall be leak-tested on completion of charging but prior to commissioning. A follow up leak test shall be carried out prior to leaving the site.

<b>Scholar Heat Pumps</b>	<b>VAH2030H</b>	<b>VDH2036H</b>	<b>VDH2040H</b>	<b>VAH2048H</b>
<b>Refrigerant Charge (oz.)</b>	170	200	200	210
<b>Scholar Air Conditioners</b>	<b>VAH2030A</b>	<b>VDH2036A</b>	<b>VDH2040A</b>	<b>VAH2048A</b>
<b>Refrigerant Charge (oz.)</b>	170	200	200	210

*Table 5. Refrigerant Charge (R-454B, Ounces)*

### 7.4 REFRIGERANT RECOVERY

When removing refrigerants from a system, either for servicing or decommissioning, it is recommended good practice that all refrigerants are removed safely. When breaking into the refrigerant circuit to make repairs – or for any other purpose – conventional procedures shall be used. However, for flammable refrigerants it is important that best practice be followed, since flammability is a consideration. The following procedure shall be adhered to:

1. Safely remove refrigerant following local and national regulations.
2. Evacuate.
3. Continuously flush or purge with inert gas when using flame to open circuit
4. Open the circuit
5. The REFRIGERANT CHARGE shall be recovered into the correct recovery cylinders. For appliances containing FLAMMABLE REFRIGERANTS other than A2L

REFRIGERANTS, the system shall be purged with oxygen-free nitrogen to render the appliance safe for FLAMMABLE REFRIGERANTS. This process may need to be repeated several times. Compressed air or oxygen shall not be used for purging refrigerant systems.

6. For appliances containing flammable refrigerants, refrigerants purging shall be achieved by breaking the vacuum in the system with oxygen-free nitrogen and continuing to fill until the working pressure is achieved, then venting to atmosphere, and finally pulling down to a vacuum (optional for A2L). This process shall be repeated until no refrigerant is within the system (optional for A2L). When the final oxygen-free nitrogen charge is used, the system shall be vented down to atmospheric pressure to enable work to take place
7. The outlet for the vacuum pump shall not be close to any potential ignition sources, and
8. Ventilation shall be available.
9. When transferring refrigerant into cylinders, ensure that only appropriate refrigerant recovery cylinders are employed. Ensure that the correct number of cylinders for holding the total system charge is available. All cylinders to be used are designated for the recovered refrigerant and labelled for that refrigerant (i.e. special cylinders for the recovery of refrigerant). Cylinders shall be complete with pressure-relief valve and associated shut-off valves in good working order. Empty recovery cylinders are evacuated and, if possible, cooled before recovery occurs.
10. The recovery equipment shall be in good working order with a set of instructions concerning the equipment that is at hand and shall be suitable for the recovery of the flammable refrigerant. If in doubt, the manufacturer should be consulted. In addition, a set of calibrated weighing scales shall be available and in good working order. Hoses shall be complete with leak-free disconnect couplings and in good condition.
11. The recovered refrigerant shall be processed according to local legislation in the correct recovery cylinder, and the relevant waste transfer note arranged. Do not mix refrigerants in recovery units and especially not in cylinders.
12. If compressors or compressor oils are to be removed, ensure that they have been evacuated to an acceptable level to make certain that flammable refrigerant does not remain within the lubricant. The compressor body shall not be heated by an open flame or other ignition sources to accelerate this process. When oil is drained from a system, it shall be carried out safely.

## Chapter 8: Decommissioning

### 8.1 DECOMMISSIONING

Before carrying out this procedure, it is essential that the technician is completely familiar with the equipment and all its details. It is recommended good practice that all refrigerants are recovered safely. Prior to the task being carried out, an oil and refrigerant sample shall be taken in case analysis is required prior to re-use of recovered refrigerant. It is essential that electrical power is available before the task commences.

1. Become familiar with the equipment and its operation.
2. Isolate the system electrically.
3. Before attempting the procedure, ensure that:
  - Mechanical handling equipment is available, if required, for handling refrigerant cylinders.
  - All personal protective equipment is available and being used correctly.
  - The recovery process is supervised at all times by a competent person.
  - Recovery equipment and cylinders conform to the appropriate standards.
4. Pump down the refrigerant system, if possible.
5. If a vacuum is not possible, make a manifold so that refrigerant can be removed from various parts of the system.
6. Make sure that cylinder is situated on the scales before recovery takes place.
7. Start the recovery machine and operate in accordance with instructions.
8. Do not overfill cylinders (no more than 80 % volume liquid charge).
9. Do not exceed the maximum working pressure of the cylinder, even temporarily.
10. When the cylinders have been filled correctly and the process completed, make sure that the cylinders and the equipment are removed from site promptly and all isolation valves on the equipment are closed off.
11. Recovered refrigerant shall not be charged into another REFRIGERATING SYSTEM unless it has been cleaned and checked.

Equipment shall be labelled stating that it has been de-commissioned and emptied of refrigerant. The label shall be dated and signed. For appliances containing FLAMMABLE REFRIGERANTS, ensure that there are labels on the equipment stating the equipment contains FLAMMABLE REFRIGERANT.

# APPENDIX A - WIRING DIAGRAMS

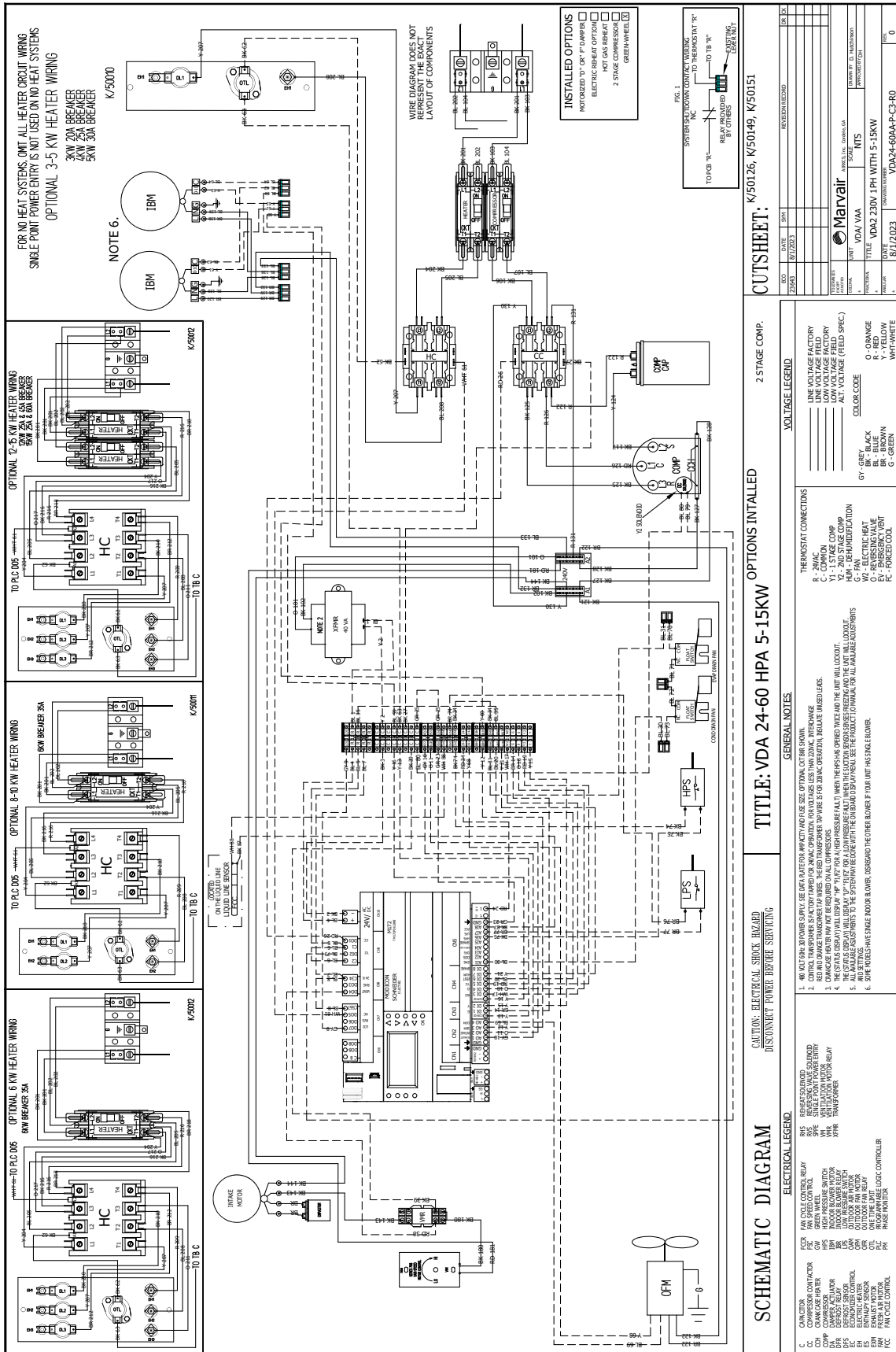
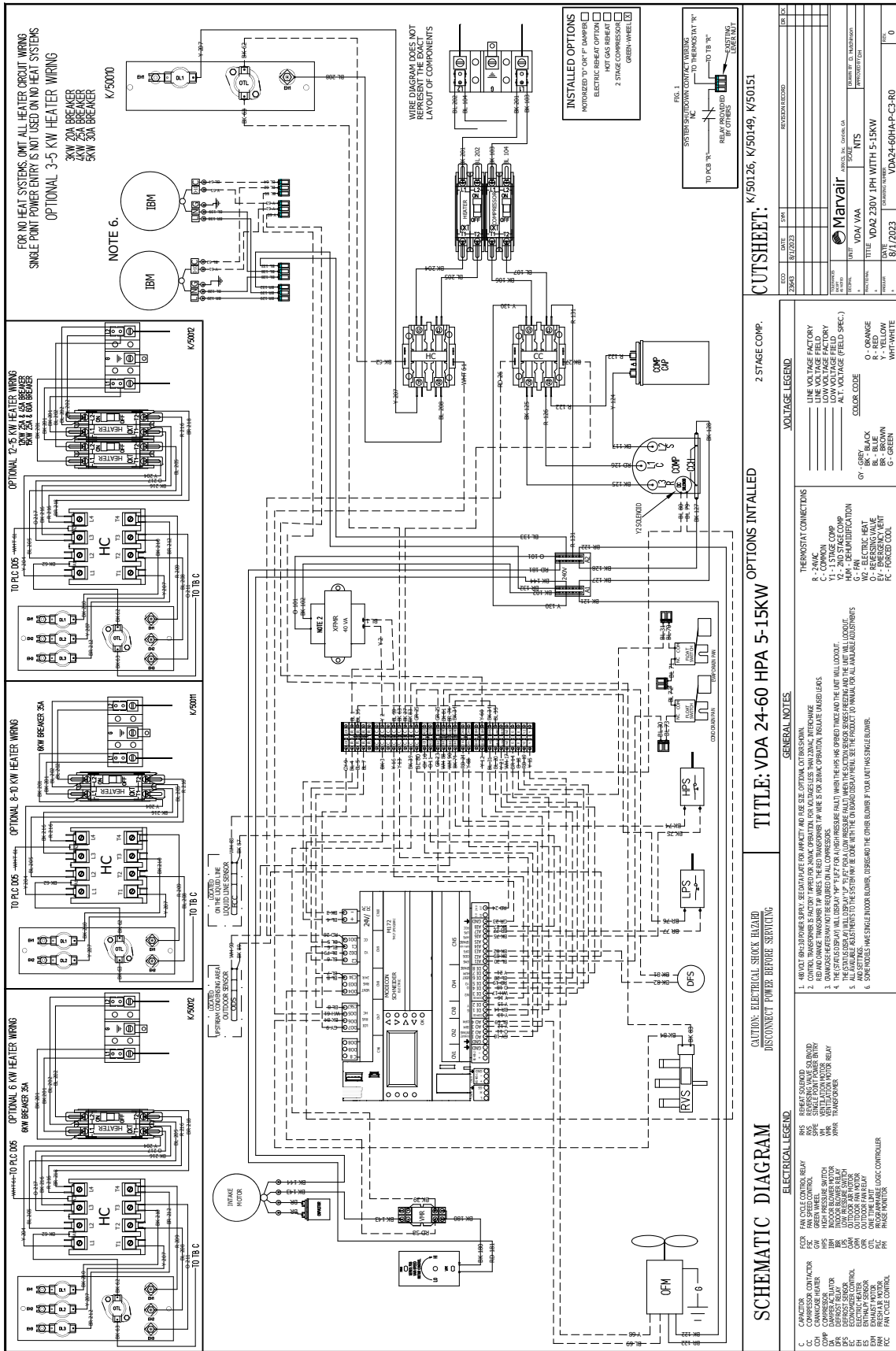
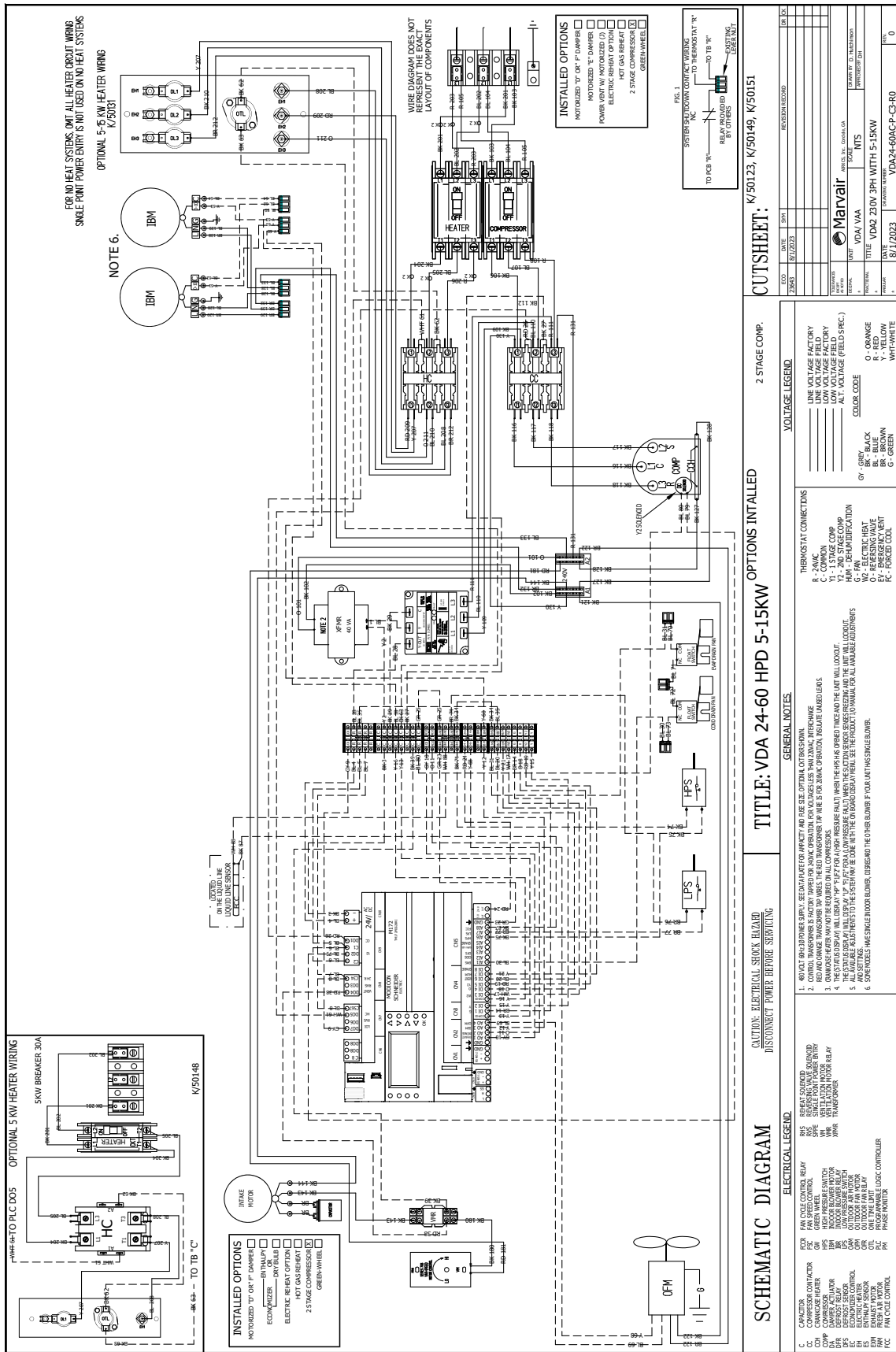


Fig 1. Typical Wiring Schematic for 240V 1-Phase Air Conditioner





**Fig 2. Typical Wiring Schematic for 240V 1-Phase Heat Pump**



**Fig 3. Typical Wiring Schematic for 240V 3-Phase Air Conditioner**



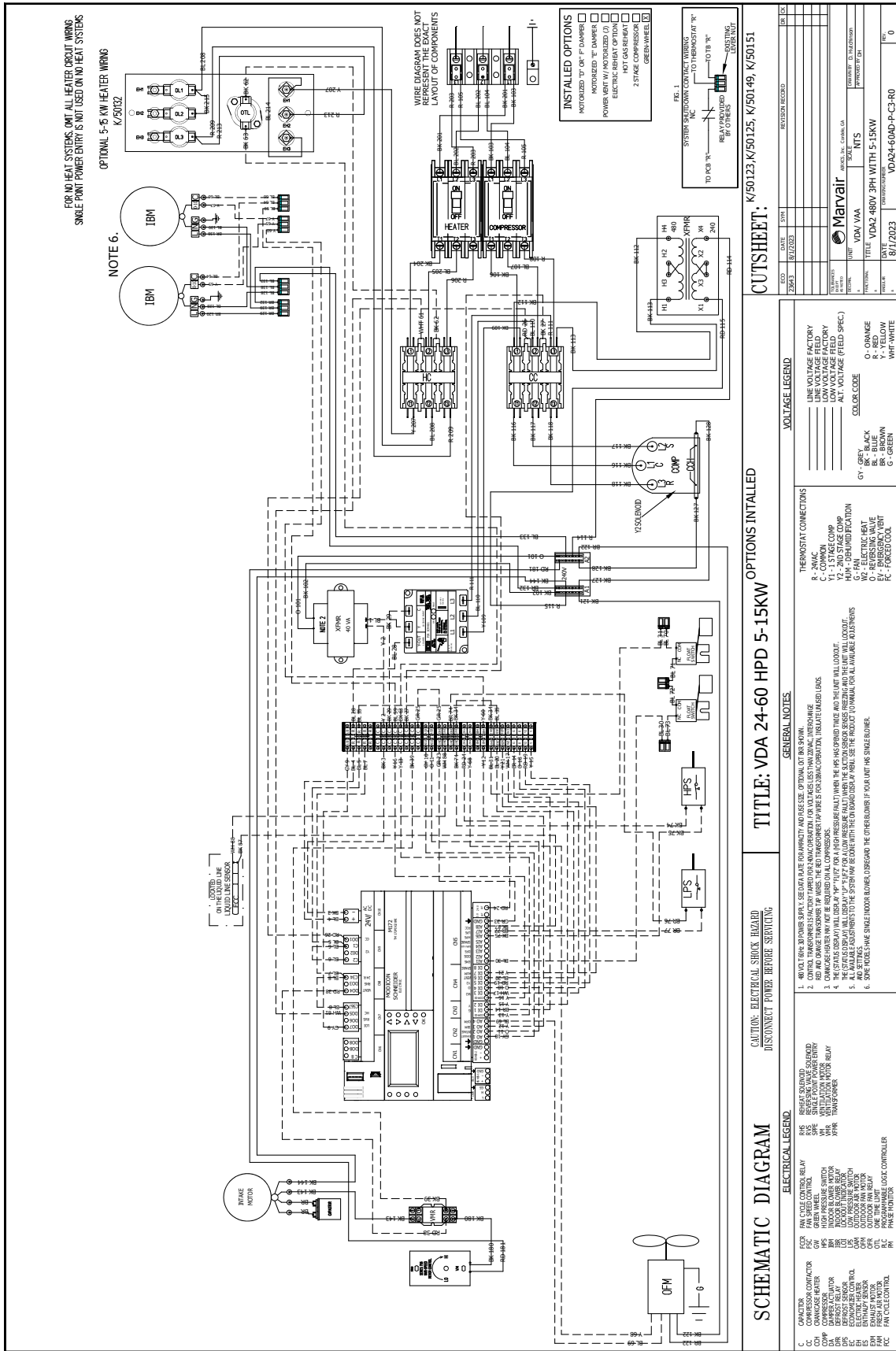


Fig 5. Typical Wiring Schematic for 480V 3-Phase Air Conditioner



## APPENDIX B - RATINGS AND DATA

### 1.01 RATINGS / DATA

AIR FLOW CFM						
BASIC MODEL	ESP (WET COIL)					
	0.10	0.15	0.20	0.30	0.40	0.50
VDH2036	1380	1340	1290	1200	—	—
VDH2040	1380	1340	1290	1200	—	—
VAH2048	1840	1780	1740	1600	1490	1400

CFM = Cubic Feet per Minute, Indoor Air Flow  
 ESP = External Static Pressure in Inches of Water Rated at 240 Volts

**Table 1. Air Flow, CFM vs. ESP (Wet Coil)**

**Note:** Follow local codes and standards when designing duct runs to deliver the required airflow. Minimize noise and excessive pressure drops caused by duct aspect ratio changes, bends, dampers and outlet grilles in duct runs.

	Qty per unit	Size	Type	MERV <sup>1</sup> Rating
Return Air Filter	3	24" x 24" x 2"	Pleated, disposable	8 <sup>2</sup>

<sup>1</sup>MERV = Minimum Efficiency Reporting Value  
<sup>2</sup>Standard return air filter has MERV rating of 7. Optional filters are available with MERV ratings of 8 and 13.

**Table 2. Air Filter Sizes (inches)**

VAH2030	Base	460V	w/GreenCube & 460V
Pounds	1020	1045	1095
VDH2036	Base	460V	w/GreenCube & 460V
Pounds	1020	1045	1095
VDH2040	Base	460V	w/GreenCube & 460V
Pounds	1030	1055	1105
VAH2048	Base	460V	w/GreenCube & 460V
Pounds	1045	1070	1120

**Table 3. Installed Weight (pounds)**

## APPENDIX C - BASE STAND INSTALLATION

### 1.01 TOOLS/FIELD FURNISHED SUPPLIES

#### WARNING

**TO AVOID PERSONAL INJURY, ADEQUATE PROTECTIVE CLOTHING MUST BE WORN AND PRECAUTIONS IN HANDLING AND INSTALLING THIS EQUIPMENT MUST BE PRACTICED AT ALL TIMES.**

- Power Drill/Driver and Extension
- Bit for 5/16" Hex Head Bolts (or Adjustable Wrench)
- Appropriate Bits for Boring Anchor Holes and Fastening Anchor Bolts Through 1/2" Pass Through Holes in Base Stand (4 Locations)

### 1.02 INSPECTION/UNPACKING/HANDLING

Base stands are shipped to the job site on wooden skids and are enclosed in shrink wrap. Do not stack the base stands.

#### IMPORTANT

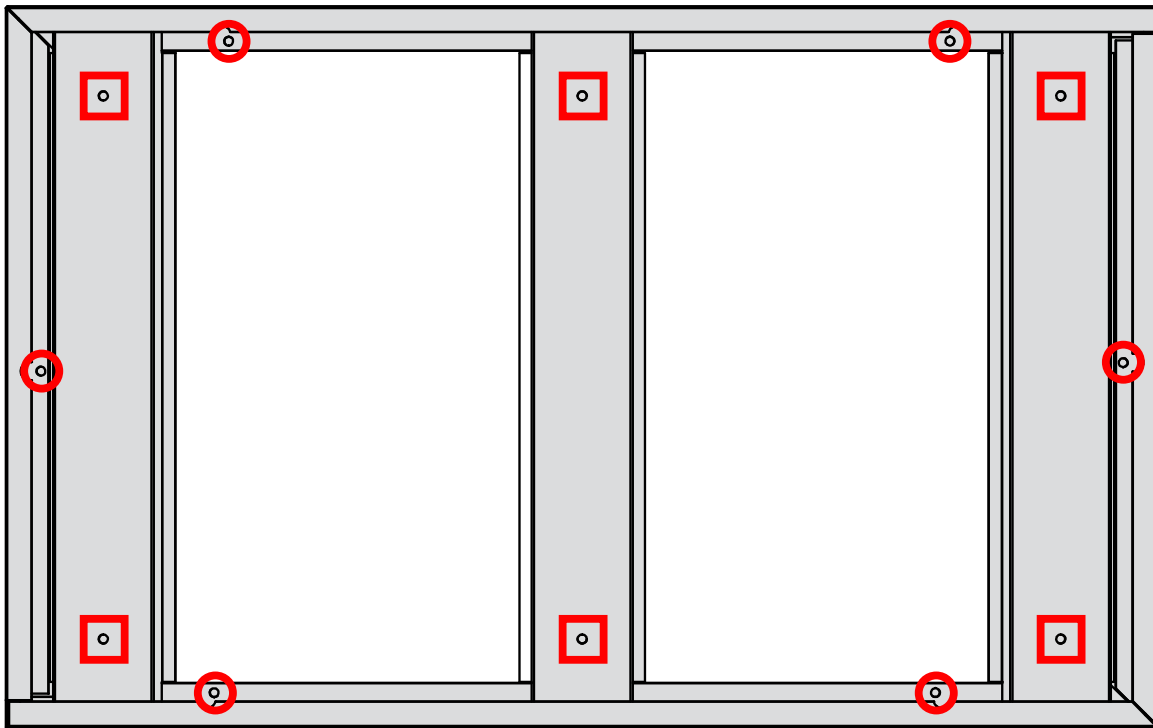
**IMMEDIATELY UPON RECEIPT, INSPECT THIS EQUIPMENT TO DETERMINE VISIBLE AND CONCEALED DAMAGE. ALL DAMAGE MUST BE REPORTED TO THE FREIGHT CARRIER WITHIN 15 DAYS, ON THE FREIGHT CARRIER'S FORM.**

The label on the base stand identifies the part number of the base stand.

Base Stand	
<u>Height</u>	<u>Part Number</u>
2"	S/06849
4"	S/06850

Remove the shrink wrap from the base stand and dispose of the wooden skid. Retain the bag of 5/16" bolts and flat washers to fasten the cabinet to the base stand. **Do not install the Scholar QR heat pump or air conditioner to the base stand at this time.**

Place the base stand (as shown in Figure 1) on the floor, measuring carefully to determine the exact location, based on where the heat pump or air conditioner is intended to be placed. It is important to be sure of base stand location when the unit is going to be located set off from the finished inside wall. The unit will be located directly on top of the base stand, and the base stand will be anchored to the floor.



- HOLES TO SECURE BASE STAND TO FLOOR
- HOLES TO SECURE SCHOLAR 2.0 STAND TO BASE STAND

**Figure 1. Top View of Base Stand**

Also, recheck the locations of the electrical and condensate stub-outs to ensure they are located properly, relative to the cabinet knock-out openings as shown in the Installation and Start-Up Manual, Figures 3 and 4.

### **IMPORTANT**

**STUBOUTS SHOULD BE LOCATED (FROM THE FLOOR OR WALL) TO ALIGN WITH SELECTED CABINET KNOCK OUT ON THE CABINET, AS SHOWN IN FIGURE 3. THIS IS A REQUIREMENT IF A BASE STAND IS TO BE INSTALLED AND STUBOUTS ARE COMING THROUGH THE FLOOR**

Lastly, remeasure to be sure that the wall opening for the Scholar QR heat pump and air conditioner air box is located properly, taking the height of the base stand into account, before proceeding to install the base stand.

## **1.03 INSTALLATION**

After the base stand is located on the floor, mark the floor in the locations where 1/2" through holes go through the bottom flange of the base stand. Be sure the floor is a hard, smooth surface and the base stand is level. If the floor is carpeted, cut out a base stand "footprint," so the base stand rests on the non-carpeted floor.

Anchor the base stand to the floor with the four field supplied anchors.

Now remove the lower front cabinet panel from the heat pump or air conditioner, removing the shipping skid bolts, air box support and installing the plenum (as appropriate), following the instructions provided in Appendix C.



 **WARNING**

**WHEN MOVING/RAISING THE SCHOLAR QR CABINET, UTILIZE ADEQUATE RESOURCES TO HANDLE THE 1,100 LB. CABINET. THIS IS TO AVOID PERSONAL INJURY OR DAMAGE TO THE EQUIPMENT/FACILITIES.**

With appropriate resources to lift the Scholar QR unit, place it on the base stand while guiding the air box through the wall opening and maintaining clearance between the plenum (as appropriate) and the ceiling. The Scholar QR heat pump aligns and rests on the base stand.

After the cabinet is resting on the base stand, align the four 3/8" through holes in the base with the receiving weld nut holes in the base stand. Thread the four 5/16" machine bolts with flat washers loosely into the base stand. Tighten bolts evenly to affix the cabinet firmly to base stand.

**IMPORTANT**

**DO NOT OVERTIGHTEN MACHINE BOLTS OR CABINET BASE WILL BOW.**

## APPENDIX D - INSTALLATION OF THE FREEBLOW PLENUM

### 1.01 TOOLS/FIELD FURNISHED SUPPLIES

#### WARNING

**TO AVOID PERSONAL INJURY, ADEQUATE PROTECTIVE CLOTHING MUST BE WORN AND PRECAUTIONS IN HANDLING AND INSTALLING THIS EQUIPMENT MUST BE PRACTICED AT ALL TIMES.**

- Power Drill/Driver and Extension
- 5/16" Nut Driver

### 1.02 INSPECTION/UNPACKING/HANDLING

Plenums are shipped to the job site on a wooden skid and are enclosed in shrink wrap. Do not stack plenums. Protect plenums from outside weather conditions. Part numbers for the freeblow plenum grilles are as follows:

<u>Part #</u>	<u>Description</u>
91969	Freeblow plenum side supply grille (two per plenum)
91970	Front supply grille (two per plenum)

#### IMPORTANT

**IMMEDIATELY UPON RECEIPT, INSPECT THIS EQUIPMENT TO DETERMINE VISIBLE AND CONCEALED DAMAGE. ALL DAMAGE MUST BE REPORTED TO THE FREIGHT CARRIER WITHIN 15 DAYS, ON THE FREIGHT CARRIER'S FORM.**

#### WARNING

**THIS EQUIPMENT MUST BE INSTALLED IN CONFORMANCE WITH ALL APPLICABLE LOCAL AND NATIONAL ELECTRICAL, PLUMBING AND BUILDING CODES.**

**THIS EQUIPMENT SHOULD BE INSTALLED AND SERVICED ONLY BY A TRAINED PROFESSIONAL HEAT PUMP SERVICE PERSON.**

#### WARNING

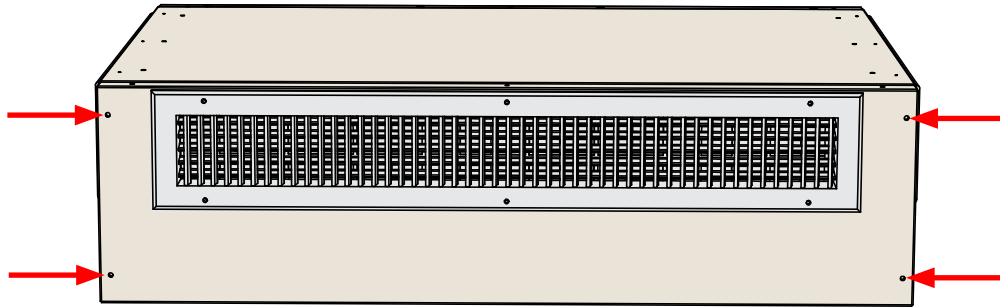
**BEFORE INSTALLING, SERVICING OR MAINTAINING THIS EQUIPMENT, SWITCH THE ELECTRIC POWER TO "OFF" AT THE DISCONNECT LOCATED BEHIND THE FRONT DOOR ON THE LOWER PANEL. FAILURE TO DO THIS COULD RESULT IN PROPERTY DAMAGE, BODILY INJURY OR DEATH.**

Remove the front plenum panel from the plenum. Retain the screws and panels for reinstallation after plenum has been installed.

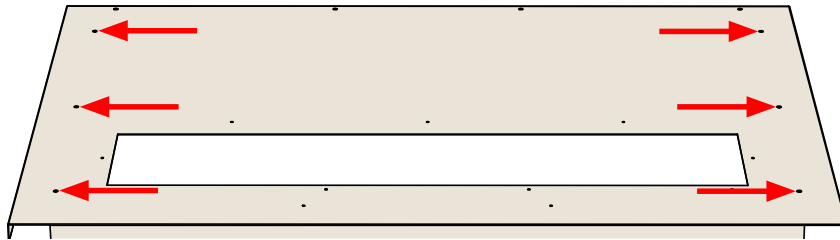
For freeblow plenum and standard height ducted plenums, the plenums should be installed onto the Scholar QR cabinet, prior to installing the cabinet into its final location. On extended height ducted plenums, the Scholar QR heat pump or air conditioner may have to be installed in its final location before the ducted plenum is fastened to the top of the cabinet.

### 1.03 PLENUM INSTALLATION

1. Prior to mounting the plenum on top of the Scholar QR unit, remove the front panel from the plenum. Retain the screws (red arrows) for reinstallation after the plenum has been installed.



2. On the top panel of the Scholar QR unit, locate the 6 holes that correspond with the six mounting holes in the plenum.

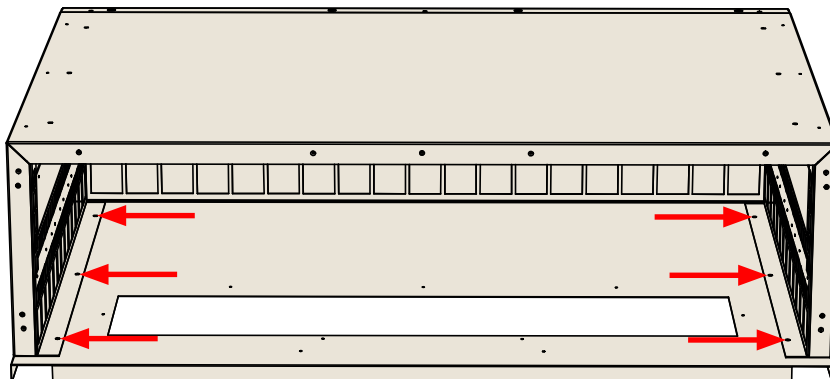


3. After the front panel has been removed, lift the plenum onto the top of the Scholar QR unit.

#### WARNING

**THE PLENUM IS HEAVY. USE CARE WHEN PLACING THE PLENUM ON TOP OF THE SCHOLAR QR HEAT PUMP OR AIR CONDITIONER.**

4. Locate the 6 holes on the side flanges (3 on each side) of the plenum.



5. Secure the plenum to the Scholar QR unit with the six  $\frac{1}{2}$ " hex head screws.
6. Attach the front panel top the front of the plenum with the six screws. Make sure that the two screws located between the supply grilles are at the top.
7. Adjust the vanes on the grilles to deliver the optimize air flow to the classroom.

The air distribution system which is field supplied and installed downstream of the specified **ducted plenum** must be engineered to assure sufficient air flow, even under adverse conditions, such as dirty filters. The information provided in Figure 1, Appendix A should be used to design the air distribution system duct size leaving the Scholar QR unit, keeping the external static pressure to a minimum.

Applications using duct work should be designed and installed in accordance with the current edition of the National Fire Protection Association codes and standards 90A and 90B. The duct system must be engineered to insure sufficient air flow through the unit to prevent over-heating of the heater element. This includes proper supply duct sizing, sufficient quantity of supply registers, adequate return and filter area. Ductwork must be of correct material and must be properly insulated. The duct work must be constructed of galvanized steel with a minimum thickness of .019. Ductwork must be firmly attached, secured and sealed to prevent air leakage. Do not use duct liner on inside of supply duct within four feet of the unit.

Galvanized metal duct extensions should be used to simplify connections to ductwork and grilles. Use fabric boots to prevent the transmission of vibration through the duct system. The fabric must be U.L. rated to a minimum of 197°F.

Auxiliary devices which may be a POTENTIAL IGNITION SOURCE shall not be installed in the duct work. Examples of such POTENTIAL IGNITION SOURCES are hot surfaces with a temperature exceeding 1,292°F (700°C) and electric switching devices.

## APPENDIX E - TRIM STRIP INSTALLATION

### 1.01 TOOLS/FIELD FURNISHED SUPPLIES



**TO AVOID PERSONAL INJURY, ADEQUATE PROTECTIVE CLOTHING MUST BE WORN AND PRECAUTIONS IN HANDLING AND INSTALLING THIS EQUIPMENT MUST BE PRACTICED AT ALL TIMES.**

- Power Drill/Driver and Extension
- Tape Measure
- Self-tapping Sheet Metal Screws, 1/2" Long (one for every foot of trim strip)
- Bit for Field Supplied Sheet Metal Screws
- Metal Saw to Cut Trim Strips to Required Lengths
- File to Debur Field Sawed/Cut Metal Edges
- Acoustical Insulation

### 1.02 INSPECTION/UNPACKING/HANDLING

Trim strips are ordered to fill the gap between the Scholar QR cabinet and the finished inside surface of the wall, when the cabinet is offset from the wall.

Trim strips are 10 inches in depth and have a 1 inch 90° flange on one end to fit flush to the finished inside wall. Trim strips can be used to accommodate cabinets with up to a 9 inch offset from the wall.

Trim strips are packaged in corrugated marked on the outside with part number 03027 and strapped to a skid for shipment to the job site. They are painted to match the cabinet color. The finished painted surfaces have a protective white film on the surface to protect the surfaces from damage. Leave the film on the painted surfaces until the strips have been installed and construction work in the area is completed.

#### **IMPORTANT**

**IMMEDIATELY UPON RECEIPT, INSPECT THIS EQUIPMENT TO DETERMINE VISIBLE AND CONCEALED DAMAGE. ALL DAMAGE MUST BE REPORTED TO THE FREIGHT CARRIER WITHIN 15 DAYS, ON THE FREIGHT CARRIER'S FORM.**

### 1.03 PREPARATION OF SCHOLAR QR HEAT PUMP AND AIR CONDITIONER FOR TRIM STRIP INSTALLATION

The Scholar QR heat pump and air conditioner cabinet and plenum (as appropriate) must be installed, with the floor fasteners in place and the outside louver installed, to ensure the fixed location of the system prior to installation of the trim strips. Check the cabinet for vertical plumb and parallelism to the inside of the finished wall prior to installing the trim strips.

### 1.04 INSTALLATION OF TRIM STRIPS

Cut the trim strips to appropriate lengths to fill the gaps between the finished inside wall and the cabinet sides and top. To reduce sound transmission through the trim strips, apply acoustical insulation on the side of the strips that face the outdoor air box.

Debur all field cut or sawed metal edges.

#### **IMPORTANT**

**CAREFULLY MARK, INDENT AND DRIVE SCREWS THROUGH THE TRIM STRIPS TO AVOID DAMAGING THE PAINTED SURFACES.**

Field supplied screws should be self tapping zinc coated sheet metal type, 1/2" long with head color of satin aluminum, to match the cabinet finish.

## APPENDIX F - OUTDOOR LOUVER/COLLAR INSTALLATION

### 1.01 TOOLS/FIELD FURNISHED SUPPLIES

#### WARNING

**TO AVOID PERSONAL INJURY, ADEQUATE PROTECTIVE CLOTHING MUST BE WORN AND PRECAUTIONS IN HANDLING AND INSTALLING THIS EQUIPMENT MUST BE PRACTICED AT ALL TIMES.**

- Power Drill/Driver and Extension
- T25 TORX Bits
- Sealant Caulk (tube)
- Caulking Applicator
- Ladder (as appropriate)
- Masonry Penetrating Fasteners (6 per collar)
- Scribe/punch

### 1.02 INSPECTION/UNPACKING/HANDLING

Louver/collar assemblies, louvers and collars are shipped to the job site in corrugated containers. Do not stack these containers. Louvers and collars are to be handled as fragile items.

#### IMPORTANT

**IMMEDIATELY UPON RECEIPT, INSPECT THIS EQUIPMENT TO DETERMINE VISIBLE AND CONCEALED DAMAGE. ALL DAMAGE MUST BE REPORTED TO THE FREIGHT CARRIER WITHIN 15 DAYS, ON THE FREIGHT CARRIER'S FORM**

- A. The following louver/collar assemblies, louvers and collars are suitable for all Scholar QR units.

<u>Part Number</u>	<u>Description</u>
93206	Clear anodized louver/collar assembly
93206-BRZ	Dark bronze louver/collar assembly

To minimize damage, remove the louver and louver parts from the corrugated container just prior to installation. Retain the bag of screws and caps for installation of the louver.

#### WARNING

**THIS EQUIPMENT MUST BE INSTALLED IN CONFORMANCE WITH ALL APPLICABLE LOCAL AND NATIONAL ELECTRICAL, PLUMBING AND BUILDING CODES.**

**THIS EQUIPMENT SHOULD BE INSTALLED AND SERVICED ONLY BY A TRAINED PROFESSIONAL HVAC SERVICE PERSON.**

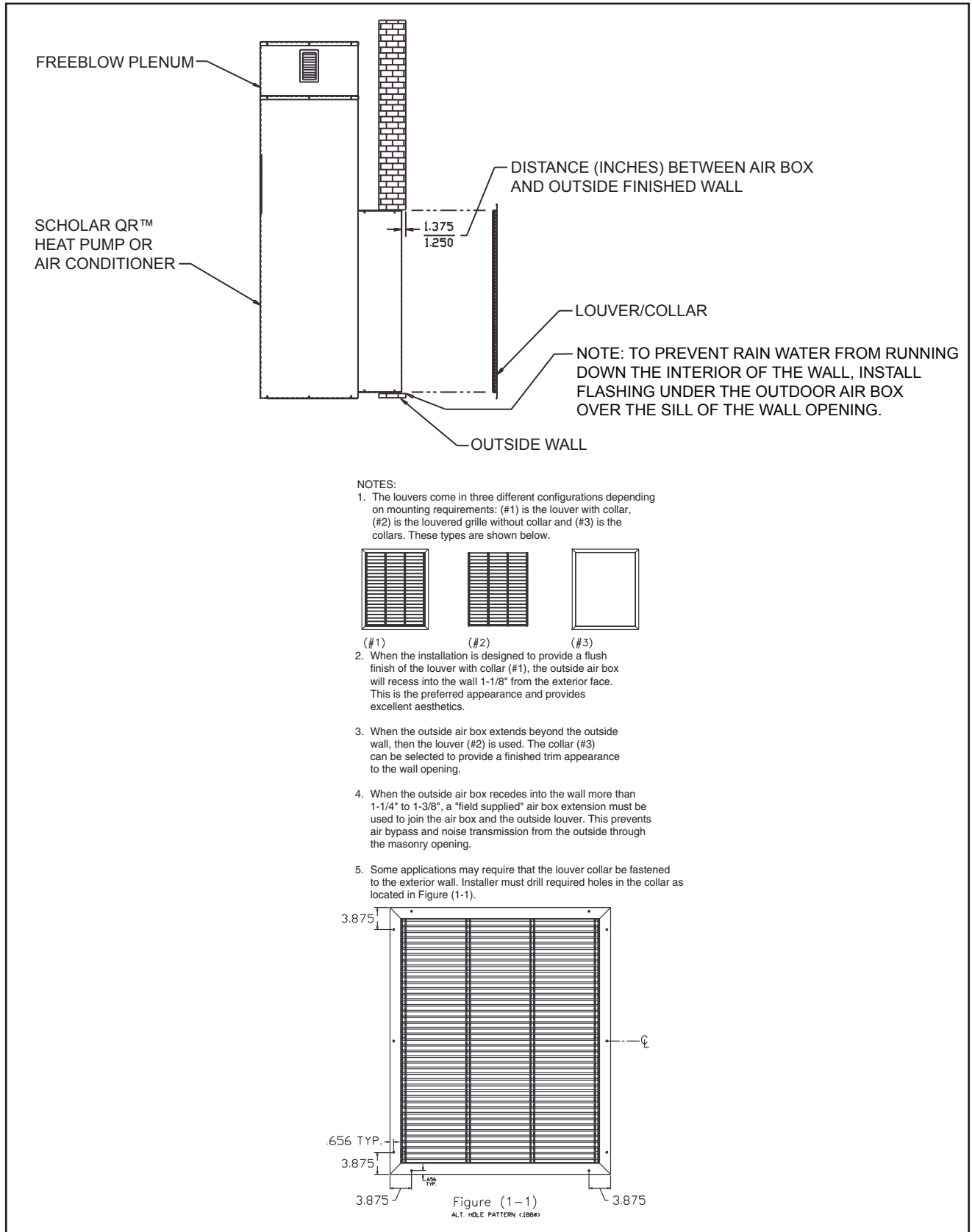
#### WARNING

**BEFORE INSTALLING, SERVICING OR MAINTAINING THIS EQUIPMENT, SWITCH THE ELECTRIC POWER TO "OFF" AT THE DISCONNECT LOCATED BEHIND THE KEY LOCKED DOOR ON THE LOWER FRONT PANEL. FAILURE TO DO THIS COULD RESULT IN PROPERTY DAMAGE, BODILY INJURY OR DEATH.**

### 1.03 PREPARATION OF SCHOLAR QR HEAT PUMP OR AIR CONDITIONER FOR LOUVER/COLLAR INSTALLATION

**Note:** Custom louvers may have installation requirements different from louvers with a collar. Follow engineer's drawings and instructions for installation of these louvers.

The Scholar QR heat pump or air conditioner should be installed following the instructions in this manual. After installation, the Scholar QR air box should be from 1-1/4" to 1-3/8" from the outside surface of the finished wall, as shown in Figure 1.



**Figure 1. Dimension between Scholar QR Air Box and Finished Outside Wall for Outdoor Louver/Collar Assembly Installation.**

 CAUTION

**WHEN FASTENING LOUVER/COLLAR ASSEMBLY TO AIR BOX (OR EXTENSION) DO NOT OVERTIGHTEN LOUVER SCREWS. OVERTIGHTENING SCREWS WILL CAUSE DAMAGE AND WARP THE LOUVER/COLLAR ASSEMBLY.**

#### 1.04 INSTALLATION OF LOUVER/COLLAR ASSEMBLY, LOUVER AND COLLAR

##### A. Louver/Collar Assembly

The preassembled louver/collar is fastened from the outside of the building in one assembly.

1. The louver/collar assembly is **fastened directly to the air box** as shown in Figure 1, with six screws supplied with the louver/collar. Prior to installing the louver, apply caulk around the perimeter flange of the outdoor air box. Be careful not to block the weep holes on the bottom flange. To ensure proper fit up of the collar to the outside wall surface, be sure the unit is positioned as shown in Figure 1. After the six screws have been installed and appropriately tightened (do not over torque), the color coordinated screw caps are snapped into place to cover the screw fastener heads. Provide a water seal around the top & both sides edges of the collar/wall interface, by applying an even bead of sealant caulk at the collar/wall interface.
2. The louver/collar assembly is **fastened directly to the outside wall**, as shown in Figure 1.

##### B. Louver

The louver itself may be fastened to the air box as shown in Figure 1.

##### C. Collar

The collar itself may be fastened to the outside wall by following the instructions in Figure 1.

#### IMPORTANT

**BE SURE AIR BOX IS PLACED 1-3/8" TO 1-1/2" INSET FROM OUTSIDE WALL SURFACE.**

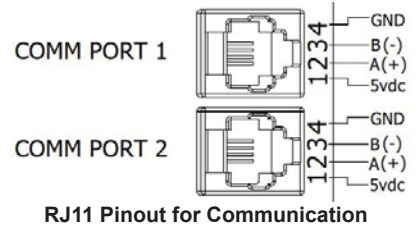
**USE LOUVER/COLLAR SCREWS THAT ARE COMPATIBLE WITH THE COLOR OF THE COLLAR.**



## Appendix G: Electronic Control Board Modbus Map

### Default Modbus RTU Settings

**Slave ID** = 1  
**Baud** = 19200  
**Data Bits** = 8  
**Stop Bits** = 1  
**Parity** = None  
 First Coil 1 , No. of Coils 30



**Discrete Bit/Bool:** Read with Function Code 02 multi discrete input read, Write to RW coil with Function Code 05 Single Coil write. Coils and DI RO share a common space. Attempted Writes to RO DI inputs result in error return. Func 0x0F multiple coil writes not supported.

MODBUS PACKET REGISTER ZeroBase ID (ZBI)	Coil ID Value, Human OBI Reference Register ID				
OFFSET	ID	Description	Size	Data Format	R/W
0	1	Current Status of the Y1 Compressor Call	1 bit	0 = no call, 1 = call	RW
1	2	Current Status of the Y2 Compressor Call	1 bit	0 = no call, 1 = call	RW
2	3	Current Status of the Humidity Call	1 bit	0 = no call, 1 = call	RW
3	4	Current Status of the G Fan Call	1 bit	0 = no call, 1 = call	RW
4	5	Current Status of the W2 Electric Heating Call	1 bit	0 = no call, 1 = call	RW
5	6	Current Status of the FCC Call	1 bit	0 = no call, 1 = call	RO
6	7	High Pressure Switch 1 Status	1 bit	0 = Open, 1 = Closed	RO
7	8	High Pressure Switch 2 Status	1 bit	0 = Open, 1 = Closed	RO
8	9	Low Pressure Switch 1 Status	1 bit	0 = Open, 1 = Closed	RO
9	10	Low Pressure Switch 2 Status	1 bit	0 = Open, 1 = Closed	RO
10	11	OFM Mode Selection	1 bit	0 = PWM, 1 = 0-10V	RO
11	12	IFM Mode Selection	1 bit	0 = PWM, 1 = 0-10V	RO
12	13	Technician Speedup Test Mode Status	1 bit	0 = Normal Mode, 1 = Test Mode	RO
13	14	Status of Compressor 1 Relay Output	1 bit	0 = Off, 1 = Energized	RO
14	15	Status of Compressor 2 Relay Output	1 bit	0 = Off, 1 = Energized	RO
15	16	Status of RH RelayOutput	1 bit	0 = Off, 1 = Energized	RO
16	17	Status of W2 RelayOutput	1 bit	0 = Off, 1 = Energized	RO
17	18	Enables/1 or Disables/0 the communicating mode thermostat functionality. Reads/modifies parameter P22. 0=H,1=C	1 bit	0 = H hardware calls, 1 = Comm/Modbus calls.	RW
18	19	Enables or disables reading the hardware thermostat call inputs (Coils1-5,25).	1 bit	0 = Normal usage based on P22. 1 = read HW calls thermostat inputs regardless of programming of P22 as C. Default is 0, normal operations.	RW
19	20	Current Status of AC / HP	1 bit	0 = AC, 1 = HP	RO
20	21	Current Status of EHDD	1 bit	0 = N, 1 = Y	RO
21	22	Current Status of SCKT	1 bit	0 = N, 1 = Y	RO
22	23	Current Status of Enable Economizer	1 bit	0 = N, 1 = Y	RO
23	24	Current Status of Economizer Sensor Type	1 bit	0 = DB, 1 = EN	RO
24	25	Current Status of O Reversing Valve request	1 bit	0 = no call, 1 = call	RW
25	26	Current Status of RV output	1 bit	0 = OFF, 1 = Energized	RO
26	27	Emergency Ventilation Request	1 bit	0 = Off, 1 = Energized	RW
27	28	Pulse Reheat	1 bit	0 = off, 1 = ON (default)	RW
28	29	Status of Emergency Ventilation	1 bit	0 = Off, 1 = ON	RO
29	30	Status of EC relay output.	1 bit	0 = Off, 1 = ON	RO

Registers: Read with Function Code 04 Multi register reads, Write to RW register with Function Code 06 write single register. Attempted Writes to RO registers result in error return. Func 0x10 multiple register writes not supported.

MODBUS PACKET REGISTER ZeroBase ID (ZBI)	Human OBI Register ID				
	ID	Description	Size	Data Format	R/W
0	40001	Heat Setpoint <b>Note:</b> Register is RW but not currently used. For future use.	16 bit	45-100 degrees Fahrenheit	RW
1	40002	Cool Setpoint <b>Note:</b> Register is RW but not currently used. For future use.	16 bit	45-100 degrees Fahrenheit	RW
2	40003	Temperature Calibration	16 bit	0-18, 9 is default. Less than 9 is a negative offset, 10-18 is a positive offset. Value minus 9 is the correction.	RW
3	40004	W2 Speed Multiplier	16 bit	0-100, 80 is default. Represents a percentage of the Y2 fan speed	RW
4	40005	Dehumidification Speed Multiplier	16 bit	0-100, 80 is default. Represents a percentage of the Y2 fan speed	RW
5	40006	OFM Set Speed	16 bit	0 - 1023	RW
6	40007	IFM Y1 Set Speed	16 bit	0 - 1023	RW
7	40008	IFM Y2 Set Speed	16 bit	0 - 1023	RW
8	40009	Modbus Timeout Setting	16 bit	1 - 60, default 10; represents minutes of allowed modbus inactivity before switching to HW call onboard t-stat mode	RW
9	40010	Current OFM Speed	16 bit	0 - 1023	RO
10	40011	Current IFM Speed	16 bit	0 - 1023	RO
11	40012	Anti Short Cycle Compressor 1	16 bit	0 - 360, 0.5 seconds per step	RO
12	40013	Anti Short Cycle Compressor 2	16 bit	0 - 360, 0.5 seconds per step	RO
13	40014	Voltage Reading	16 bit	0-1023, 1023 = Greater than 20V 965 = 18V cutoff	RO
14	40015	P1 Temperature Reading	16 bit	0-160 degrees Fahrenheit, 255 no sensor	RO
15	40016	P2 Temperature reading	16 bit	0-160 degrees Fahrenheit, 255 no sensor	RO
16	40017	Freeze Sensor 1 Temperature Reading	16 bit	0-160 degrees Fahrenheit, 255 no sensor	RO
17	40018	Freeze Sensor 2 Temperature Reading	16 bit	0-160 degrees Fahrenheit, 255 no sensor	RO
18	40019	Alarm Status	16 bit	0 = No Fault D0 = FLAT CIRCUIT FAULT D1 = HPS1 Fault D2 = Low Voltage D3 = Future Use D4 = Future Use D5 = Future Use D6 = LPS1 Fault D7 = Future Use D8 = Future Use D9 = Future Use D10 = Future Use D11 = Future Use D12 = Future Use D13 = Future Use D14 = Y1 Locked Out D15 = Y2 Locked Out	RO

19	40020	Current Status of MIN POS	16 bit	20 = MIN, 20-100= OPEN %	RW
20	40021	Economizer Dry Bulb Temperature setpoint	16 bit	70F=default, 20F-105F	RW
21	40022	ODS set	16 bit	50 default, 0-70	RW
22	40023	Fan Purge	16 bit	N= 0, 10-90 SECONDS, 90 SEC IS DEFAULT	RW
23	40024	Defrost Timer	16 bit	30= default, 30, 60, 90 minutes	RW
24	40025	Current SW version number	16 bit	display sw version decimal	RO
25	40026	Supply/Mixed Air Temp reading	16 bit	0-160 degrees Fahrenheit	RO
26	40027	SAS/MAS calibration	16 bit	0-18, 9 is default. Less than 9 is a negative offset, 10-18 is a positive offset. Value minus 9 is the correction.	RW
27	40028	Outdoor Temp reading	16 bit	0-160 degrees Fahrenheit	RO
28	40029	ODS Calibration	16 bit	0-18, 9 is default. Less than 9 is a negative offset, 10-18 is a positive offset. Value minus 9 is the correction.	RW
29	40030	LPS1 / Suction Line Temp reading	16 bit	0-160 degrees Fahrenheit, 255 if open or shorted sensor	RO
30	40031	Suction Line Temp Calibration	16 bit	0-18, 9 is default. Less than 9 is a negative offset, 10-18 is a positive offset. Value minus 9 is the correction.	RW
31	40032	FCC1 / Liquid Line temp reading	16 bit	0-160 degrees Fahrenheit, 255 if open or shorted sensor	RO
32	40033	Liquid Line temp Calibration	16 bit	0-18, 9 is default. Less than 9 is a negative offset, 10-18 is a positive offset. Value minus 9 is the correction.	RW
33	40034	DS Temp (defrost sensor temp) reading	16 bit	0-160 degrees Fahrenheit	RO
34	40035	DS calibration	16 bit	0-18, 9 is default. Less than 9 is a negative offset, 10-18 is a positive offset. Value minus 9 is the correction.	RW
35	40036	Dehumidifier Setpoint	16 bit	Default 72 F, 70 - 75F	RW
36	40037	Pulse Reheat Differential	16 bit	Default 5 F, 5 - 10F	RW
37	40038	Economizer setpoint Entrophy Mode A..E as 0..4	16 bit	Default 3/D	RW
38	40039	ECO output status	16 bit	0 = off, 20-100	RO