



Heat Pump Product Manual

Vertical Wall-Mount Heat Pumps

Installation & Operation Manual

Vertical Wall-Mount Heat Pumps

Single Stage Models:

MAA1020H • MAA1024H • MAA1030H
MAA1036H • MAA1042H • MAA1048H
MAA1060H

2-Stage Models:

MAA2024H • MAA2030H • MAA2036H
MAA2042 • MAA2048H • MAA2060H



This manual may include information for options and features which may not be included on the unit being installed. Refer to the unit data label or Model Identification to determine which features and options this unit is equipped with.

INSTALLER: Affix the instructions on the inside of the building adjacent to the thermostat.
END USER: Retain this manual for future reference.

Manufactured By:

Marvair, An AirX Climate Solutions Brand

P.O. Box 400 • Cordele, Georgia 31010 • 156 Seedling Drive • Cordele, Georgia 31015
(229) 273-3636 • Fax (229) 273-5154

E-mail: marvairsales@airxcs.com • Internet: www.Marvair.com

The most current version of this manual can be found at www.Marvair.com.

How To Use This Manual

This manual is intended to be a comprehensive guide to the installation of the Marvair® MAA family of vertical packaged heat pumps. It contains installation, troubleshooting, maintenance, warranty, and application information. The information contained in this manual is to be used by the installer as a guide only. This manual does not supersede or circumvent any applicable national or local codes. For information on the efficiency, cooling and heating performance, please refer to the Product Data Sheets. The most current version of all literature can be found on our website at www.Marvair.com.

If you are installing the heat pump unit, first read Chapter 1 and scan the entire manual before beginning the installation as described in Chapter 2. Chapter 1 contains general, descriptive information and provides an overview which can speed up the installation process and simplify troubleshooting.

If a malfunction occurs, follow this troubleshooting sequence:

1. Make sure you understand how the heat pump unit works (Chapters 1 & 3).
2. Identify and correct installation errors (Chapter 2).
3. Refer to the troubleshooting information in Chapter 4.
4. Identify defective part(s). (Chapter 5).



If you are still unable to correct the problem, contact the Factory at 1-800-841-7854 for additional assistance.

Please read the following “Important Safety Precautions” before beginning any work. Failure to follow these rules may result in death, serious bodily harm, property damage and damage to the equipment.

Important Safety Precautions

1. USE CARE when LIFTING or TRANSPORTING equipment.
2. TRANSPORT the UNIT UPRIGHT. Laying it down on its side may cause oil to leave the compressor and breakage or damage to other components.
3. TURN ELECTRICAL POWER OFF AT THE breaker or fuse box BEFORE installing or working on the equipment. LINE VOLTAGES ARE HAZARDOUS or LETHAL.
4. OBSERVE and COMPLY with ALL applicable PLUMBING, ELECTRICAL, and BUILDING CODES and ordinances.
5. SERVICE may be performed ONLY by QUALIFIED and EXPERIENCED PERSONS.
 - * Wear safety goggles when servicing the refrigeration circuit
 - * Beware of hot surfaces on refrigerant circuit components
 - * Beware of sharp edges on sheet metal components
 - * Use care when recovering or adding refrigerant
6. Use COMMON SENSE - BE SAFETY-CONSCIOUS

This is the safety alert symbol . When you see this symbol on the unit and in the instruction manuals be alert to the potential for personal injury. Understand the signal word DANGER, WARNING, CAUTION and IMPORTANT. These words are used to identify levels of the seriousness of the hazard.

 DANGER	Failure to comply will result in death or severe personal injury and/or property damage.
 WARNING	Failure to comply could result in death or severe personal injury and/or property damage.
 CAUTION	Failure to comply could result in minor personal injury and/or property damage.
IMPORTANT	Used to point out helpful suggestions that will result in improved installation, reliability or operation.

SPECIFICATIONS SUBJECT TO CHANGE WITHOUT NOTICE.

© 08/2024 Marvair, An AirX Climate Solutions Brand

 **WARNING**

- If the information in these instructions are not followed exactly, a fire may result causing property damage, personal injury or loss of life.
- Read all instructions carefully prior to beginning the installation. Do not begin installation if you do not understand any of the instructions.
- Improper installation, adjustment, alteration, service or maintenance can cause property damage, personal injury or loss of life.
- Installation and service must be performed by a qualified installer or service agency in accordance with these instructions and in compliance with all codes and requirements of authorities having jurisdiction.

INSTALLER: Affix the instructions on the inside of the building adjacent to the thermostat.
END USER: Retain these instructions for future reference.

TABLE OF CONTENTS

Chapter 1 - Description & Specifications

1.1	General Description.....	5
1.2	Serial Number Date Code	5
1.3	Model Identification	6
1.4	Air Flow, Weights, Filter Sizes, Refrigerant Charges and Ambient Operating Ranges.....	6
1.5	General Operation	7
1.6	Options	10

Chapter 2 - Electronic Control Board

2.1	Introduction.....	12
2.2	Installation and Replacement	13
2.3	PCB Details and Information	13
2.4	Operation.....	17
2.5	Sequence of Operation	17

Chapter 3 - Installation

3.1	Equipment Inspection.....	29
3.2	Installation Requirements.....	29
3.3	Installation Materials	30
3.4	Porting and Duct Work	32
3.5	Fresh Air Hood Adjustment	33
3.6	Bracket Installation	33
3.7	Mounting the Unit	34
3.8	Electrical Connections.....	35

Chapter 4 - Start-Up

4.1	Check-Out of Cooling Cycle	38
4.2	Check-Out of Heating Cycle.....	39
4.3	Discharge Air Adjustment for Modulating Hot Gas Reheat (HGR) Valve	39
4.4	Ventilation System Set Up	41

Chapter 5 - Troubleshooting	
5.1 Overview	42
5.2 Failure Symptoms Guide.....	43
5.3 Compressor Troubleshooting	44
5.4 Control Board Diagnosis.....	44
5.4 Electric Heat Controls	45
Chapter 6 - Electrical Schematics	
6.1 Electrical Schematics	46
Chapter 7 - Periodic Maintenance Requirements	
7.1 Scheduled Maintenance.....	50
Chapter 8 - Warranty Information	
8.1 Standard Product Warranty.....	51
Appendix A	
Electronic Control Board Modbus Map.....	52
Appendix B	
Installation Instructions for Field Installed Electric Heaters	55
Appendix C	
Heat Pump Start-Up - Commissioning Checklist	58
FIGURES	
Figure 1 PC Control Board.....	12
Figure 2 Enthalpy Sensor Temperature Control Points	22
Figure 3 Dry Bulb Sensor	23
Figure 4 Fresh Air Hood Damper	33
Figure 5 Heat Pump Wall Mounting Detail.....	34
Figure 6a Humidity Control Wiring Detail	36
Figure 6b Thermostat Connection Diagram	37
Figure 7 Temperature Sensor Wires - Modulating HGR Valve	40
Figure 8 Desired Temperature Set Point - Modulating HGR Valve	40
Figure 9 Typical Configuration for Single Element Heater	45
Figure 10a Typical 1ø Electrical Schematic Diagram Heat Pump with Manual Outside Air Damper.....	47
Figure 10b Typical 208/230v. 3ø Heat Pump Electrical Schematic Diagram.....	48
Figure 10c Typical 460v. 3ø Heat Pump Electrical Schematic Diagram, with PC Control Board.....	49
TABLES	
Table 1 CFM @ External Static Pressure.....	7
Table 2 Ship Weight	7
Table 3 Filter Sizes	7
Table 4 Refrigerant Charge.....	7
Table 5 Ambient Temperature Operating Ranges	7
Table 6 Minimum Clearances	30
Table 7 Voltage Limitations.....	30

Chapter 1 Description and Specifications

1.1 General Description

Marvair® Wall Mount Heat Pumps are high efficiency, vertical wall mounted heat pumps that provide heating, cooling and ventilation for a wide range of applications. Single stage nominal cooling capacities range from 20,000 to 60,000 BTUH. 2-Stage units have nominal cooling capacities from 24,000 to 60,000 BTUH.

All models have EER's of 11.00 and feature quiet operation. Resistance heating is available in all models. Please see appendix A for the installation instructions on field installing electric heaters.

Marvair heat pumps are designed for easy installation and service. All units have built-in side mounting flanges and are shipped with a bottom support bracket. The unit has been factory charged. Service ports have been provided for field service, if required. All internal wiring is complete.

Marvair MAA heat pump models are available in a wide variety of styles and configurations to meet the various ventilation and cooling requirements. For school classrooms, models are available to comply with the ASHRAE 62-1999 standard, "Ventilation for Acceptable Indoor Air Quality." Where cooling is required during cool or cold weather, e.g., telecommunication shelters, a factory-installed economizer can be used. To insure proper operation and optimum performance, all outside air ventilation packages and the economizer are non-removable, factory installed and tested. Instructions for the MAA models with the GreenWheel® ERV are included in this manual.

All Marvair heat pumps are tested and certified for efficiency and capacity in accordance with the ANSI/AHRI (Air-Conditioning, Heating and Refrigeration Institute) Standard 390-2017 (Single Package Vertical Units). All MAA models meet or exceed the efficiency requirements of ANSI/ASHRAE/IESNA 90.1.2019. All heat pump models are listed by ETL and tested to UL standard 1995, 4th Edition. Marvair heat pumps are commercial units and are not intended for use in residential applications.

1.2 Serial Number Date Code

20 = 2020	01 = January	05 = May	09 = September
21 = 2021	02 = February	06 = June	10 = October
22 = 2022	03 = March	07 = July	11 = November
23 = 2023	04 = April	08 = August	12 = December

1.3 Model Identification

Example	M	A	A	1	0	3	6	H	A	0	5	0	C	+	+	R	+	1	E	A	+	A	3	1	+	+	+	+	+	+
Position	1	2	3	4	5	6	7	8	9	10	11	12	13	14	15	16	17	18	19	20	21	22	23	24	25	26	27	28	29	30

1	Unit Designation/Family	M = Marvair Wall Mount S = Stock Unit		17 Indoor Air Quality Features 18 Air Flow 19 Compressor Location 20 Filter Option 21 Corrosion Protection 22 Engineering Revision Level 23 24 Cabinet Color 25 Sound Attenuation 26 Security Option 27 Fastener/Drain Pan Option 28 Miscellaneous 29 Unused 30 Special Variation	A = UV Light D = Dry Bulb Sensor E = Dry Bulb Sensor w/Dirty Filter G = Dirty Filter Sensor K = Bi-Polar Ionization M = Dry Bulb Sensor & CO2 Sensor (Only w/Economizer) + = None \$ = Special	
2	Energy Efficiency Ratio (EER)	A = 11			1 = Top Supply/Center Return (STD) \$ = Special	
3	Refrigerant Type	A = R-410a			D = Left Hand - All 3½ to 5 ton units E = Right Hand - All 1½ to 3 ton units	
4	Compressor Type/Quantity	1 = Single Stage Compressor 2 = 2-Stage Compressor			A = 2" Pleated (MERV 8, AC/HP-C) C = 2" Charcoal D = MERV 11 High Filtration Package E = MERV 13 High Filtration Package F = Filter Access Through Return Air Grille W = Aluminum Washable + = None \$ = Special	
5	Unit Capacity/Nominal Cooling (BTUH)	020 = 20,000	042 = 42,000		20 Filter Option 21 Corrosion Protection 22 Engineering Revision Level 23 24 Cabinet Color 25 Sound Attenuation 26 Security Option 27 Fastener/Drain Pan Option 28 Miscellaneous 29 Unused 30 Special Variation	A = Condenser Coil Only C = Evaporator Coil Only D = Both Coils Condenser & Evaporator E = All Coils Cond/Evap/Reheat F = Coat All G = Coastal Package & Evaporator Coil K = Coastal Package + = None \$ = Special
6		024 = 24,000	048 = 48,000			
7		030 = 30,000	060 = 60,000			
8		036 = 36,000				
8	System Type	H = Heat Pump			A = 2" Pleated (MERV 8, AC/HP-C) C = 2" Charcoal D = MERV 11 High Filtration Package E = MERV 13 High Filtration Package F = Filter Access Through Return Air Grille W = Aluminum Washable + = None \$ = Special	
9	Power Supply (Volts-Hz-Phase)	A = 208/230-60-1 D = 460-60-3 C = 208/230-60-3			A = Condenser Coil Only C = Evaporator Coil Only D = Both Coils Condenser & Evaporator E = All Coils Cond/Evap/Reheat F = Coat All G = Coastal Package & Evaporator Coil K = Coastal Package + = None \$ = Special	
10	Heat Designation @ Rated Voltage	000 = No Heat	090 = 9KW		20 Filter Option 21 Corrosion Protection 22 Engineering Revision Level 23 24 Cabinet Color 25 Sound Attenuation 26 Security Option 27 Fastener/Drain Pan Option 28 Miscellaneous 29 Unused 30 Special Variation	A = Condenser Coil Only C = Evaporator Coil Only D = Both Coils Condenser & Evaporator E = All Coils Cond/Evap/Reheat F = Coat All G = Coastal Package & Evaporator Coil K = Coastal Package + = None \$ = Special
11		040 = 4KW	100 = 10KW			
12		050 = 5KW	120 = 12KW			
12		060 = 6KW	150 = 15KW			
12	080 = 8KW					
13	Ventilation Configuration	C = Economizer D = Motorized Damper w/Pressure Relief E = Motorized Damper w/Pressure Relief & Independent Motorized Damper Control H = GreenWheel® ERV N = Barometric Damper w/15% OSA + = None \$ = Special			A = Condenser Coil Only C = Evaporator Coil Only D = Both Coils Condenser & Evaporator E = All Coils Cond/Evap/Reheat F = Coat All G = Coastal Package & Evaporator Coil K = Coastal Package + = None \$ = Special	
14	Dehumidification	G = Hot Gas Reheat R = Electric Reheat T = Electric Reheat w/Humidity Control + = None \$ = Special			A = Condenser Coil Only C = Evaporator Coil Only D = Both Coils Condenser & Evaporator E = All Coils Cond/Evap/Reheat F = Coat All G = Coastal Package & Evaporator Coil K = Coastal Package + = None \$ = Special	
15	Controls	A = Power Fail Alarm w/Additional Lockouts C = 24V EMS Relay Kit + = None \$ = Special		A = Condenser Coil Only C = Evaporator Coil Only D = Both Coils Condenser & Evaporator E = All Coils Cond/Evap/Reheat F = Coat All G = Coastal Package & Evaporator Coil K = Coastal Package + = None \$ = Special		
16	Operating Condition	A = Evaporator Freeze Sensor (EFS) C = EFS w/Hot Gas Bypass D = Desert Duty E = Extreme Duty F = Desert Duty w/Hard Start G = Desert Duty w/EFS H = Desert Duty w/Hard Start & EFS J = Extreme Duty w/Hard Start K = Extreme Duty w/EFS M = Extreme Duty w/Hard Start & EFS N = Hard Start P = Hard Start w/Low Ambient & CCH Q = Hard Start w/Low Ambient & Fan Cycle Control (FCC) R = Crank Case Heater (CCH) T = Hard Start w/EFS U = Hard Start w/Hot Gas Bypass V = Hard Start w/Low Ambient & CCH & EFS W = Low Ambient w/CCH X = Hot Gas Bypass Y = Low Ambient w/CCH & FCC Z = Low Ambient w/CCH & EFS 1 = Low Ambient w/FCC 2 = Low Ambient w/FCC & EFS 3 = CCH w/Hot Gas Bypass + = None \$ = Special		A = Condenser Coil Only C = Evaporator Coil Only D = Both Coils Condenser & Evaporator E = All Coils Cond/Evap/Reheat F = Coat All G = Coastal Package & Evaporator Coil K = Coastal Package + = None \$ = Special		

Note: Not all options are available with all configurations. Contact your Marvair sales representative for configuration details and feature compatibility.

1.4 Air Flow, Weights, Filter Sizes, Refrigerant Charges and Ambient Operating Ranges

Model Number	External Static Pressure (WET COIL)					
	0.10	0.20	0.25	0.30	0.40	0.50
MAA1020H/1024H/2024H	889	831	820	801		
MAA1030H/2030H	1152	1122	1100	1075	1028	
MAA1036H/2036H	1265	1222	1200	1175	1133	
MAA1042H/2042H		1650	1585	1520	1450	1360
MAA1048H/2048H		1693	1650	1619	1591	1529
MAA1060H/2060H		1693	1650	1619	1591	1529

Air flow ratings of 208-230v. Units are at 230v. Air flow ratings of 480 v. units are at 460 volts. Operation of units at a different voltage from the rating point will affect air flow.

Table 1. Air Flow (Cubic Feet per Minute)

Model	Weight	Base	w/Economizer	w/3 Phase	w/Economizer & 3 Phase
MAA1020H/MAA1024H/MAA2024H	Lbs (Kg)	337 (153)	357 (162)	356 (161)	376 (171)
MAA1030H/MAA1036H/MAA2030H/MAA2036H	Lbs (Kg)	397 (180)	419 (190)	416 (189)	438 (199)
MAA1042H/MAA1048H/MAA2042H/MAA2048H	Lbs (Kg)	453 (205)	476 (216)	491 (223)	514 (233)
MAA1060H/MAA2060H	Lbs (Kg)	469 (213)	492 (223)	522 (237)	545 (247)

Table 2. Installed Weight (lbs (Kg))

Model	FILTER TYPE	INCHES	MILLIMETERS	PART NUMBER	FILTERS PER UNIT	MERV RATING
MAA1020H/MAA1024H/MAA2024H	Return Air Filter	30 x 16 x 2	762 x 406 x 51	80138	1	8 (STD)
MAA1030H/MAA1036H/MAA2030H/MAA2036H	Return Air Filter	36½ x 22 x 2	927 x 559 x 51	80162	1	8 (STD)
MAA1042H/MAA1048H/MAA2042H/MAA2048H	Return Air Filter	36½ x 22 x 2	927 x 559 x 51	80162	1	8 (STD)
MAA1060H/MAA2060H	Return Air Filter	18 x 24 x 1	457 x 610 x 25	81199	2	8 (STD)

Table 3. Filter Size (inches)

Model	MAA1020H	MAA1024H			MAA1030H			MAA1036H			MAA1042H			MAA1048H			MAA1060H		
	A	A	C	D	A	C	D	A	C	D	A	C	D	A	C	D	A	C	D
Charge Amount	100	110			114			130			185			185			185		

Model	MAA2024H			MAA2030H			MAA2036H			MAA2042H			MAA2048H			MAA2060H		
	A	C	D	A	C	D	A	C	D	A	C	D	A	C	D	A	C	D
Charge Amount	120			120			150			185			185			220		

Table 4. Refrigerant Charge (R410A, Ounces)

Basic Model	Special Option	TEMPERATURE RANGES
Non-Economizer	Base Unit	*20°F - 131°F (-7°C - 55°C)
	Desert Duty	*20°F - 131°F (-7°C - 55°C)
	Extreme Duty	*0°F - 131°F (-18°C - 55°C)
Economizer-Equipped	Base Unit	-40°F - 131°F (-29°C - 55°C)
	Desert Duty	-40°F - 131°F (-29°C - 55°C)
	Extreme Duty	-40°F - 131°F (-29°C - 55°C)

**An Optional FCC switch is required for the cooling Mode. Heating mode ratings are @47°F Outdoor Temperature. Performance loss realized below this rating point.

Table 5. Ambient Temperature Operating Ranges

1.5 General Operation

Refrigerant Cycle

Marvaair heat pumps use R-410A refrigerant in a conventional vapor-compression refrigeration cycle to transfer heat. In the cooling mode, a double blower assembly blows indoor air across the evaporator (indoor coil). Liquid refrigerant passing through the evaporator is boiled into gas by heat removed from the air. The warmed refrigerant gas enters the compressor where its temperature and pressure are increased. The hot refrigerant gas condenses to liquid as heat is transferred to outdoor air blown across the condenser (outdoor coil) by the condenser fan. Liquid refrigerant is metered into the evaporator through a metering device to repeat the cycle. In the heating mode, the process is reversed.

Heating Mode

During heating mode a special reversing valve reverses the flow of refrigerant through the system exchanging the roles of the condenser and evaporator. Now the outdoor coil becomes the evaporator and the indoor coil becomes the condenser. The refrigerant then flows through the outdoor coil, picks up heat and becomes vaporized. The vapor then enters the compressor where it is compressed to a higher pressure and temperature. Next it is pumped to the indoor coil where the heat will be released into the room. The compressed refrigerant vapor will condense to its liquid state as it gives up heat. Finally, liquid flows through a metering device into the evaporator where the cycle will be repeated.

Optional electric strip heat is available for all models. Please see Appendix A for instructions on field installation of electric heat.

Ventilation Options

ASHRAE standard 62 requires 15 cfm of outside air per occupant of a classroom. To meet this requirement, Marvair offers seven ventilation packages for every budget and requirement.

Configuration “C”: Up to 100% Modulating Economizer

The economizer reduces the cost of air conditioning by using outside air when acceptable to cool the room (Free Cooling). The factory installed Marvair® economizer has integral pressure relief.

Control Board Logic: Upon a “Call for Cooling”, the economizer control board calculates whether the HVAC operates in economizer mode or mechanical cooling mode based on outdoor temperature (dry bulb) or temperature/humidity (enthalpy). When outdoor conditions are favorable for economizer cooling, the damper drives open and modulates to maintain a 55°F mixed air temperature through the supply grille. When outdoor conditions are not favorable for economizer cooling, the economizer damper remains closed, and the HVAC unit will operate in mechanical cooling mode.

Features Designed for Telecommunication applications:

Hydrogen Fault Input: When 24VAC is applied to the Emergency Ventilation (EV) input, the economizer board forces the damper to open 100% for emergency ventilation. The compressor does not operate during Hydrogen Fault/Emergency Ventilation.

Forced Mechanical Cooling: When 24VAC is applied to the FC input of the economizer board, the economizer damper is forced closed, and the HVAC will operate in mechanical cooling mode. This is considered as economizer override in the event economizer cooling is not sufficient for the heat load. Thermostat must provide the fan “G” signal to HVAC to activate the indoor blower.

Economizer Status: The economizer board has contacts that when used with the Marvair CommStat 4 Telecom HVAC Controller, change state to provide feedback to the CommStat 4 to indicate when the HVAC is in economizer mode versus mechanical cooling mode. This feedback allows the CommStat 4 to initiate the forced cooling feature to override economizer cooling and force mechanical cooling.

When used with minimum position potentiometer (optional), the Marvair® economizer can meet requirements of ASHRAE Std. 62.

Configuration “D”: Two-Position Motorized Fresh Air Damper w/Pressure Relief Ventilation

Control Board Logic: The 92589 control board allows the position of the “D” damper to be set for desired outside air intake from fully closed to fully open. Setting 15 of the control board configuration menu allows the user to set the position from 20 (2VDC / Closed) to 100 (10VDC 100% open). The damper position can be adjusted in 1VDC increments to any position from closed to 100% open as required.

Operation: Anytime the indoor blower operates, the damper drives open to the position selected in the control board configuration menu setting 15. When the indoor blower stops operation the motorized damper spring returns to the fully closed position.

Note: This circuit does not interrupt the compressor or heater operation.

Configuration “E”: Two-Position Motorized Fresh Air Damper w/Pressure Relief Ventilation & Independent Control

Control Board/Factory Installed Relay Logic: The 92589 control board allows the position of the “E” damper to be set for desired outside air intake from fully closed to fully open. Setting 15 of the control board configuration menu allows the user to set the position from 20 (2VDC / Closed) to 100 (10VDC 100% open). The damper position can be adjusted in 1VDC increments to any position from closed to 100% open as required.

Operation: Upon a “Call for Motorized damper” via a 24V signal from an external user-installed device, the motorized damper opens to the position selected in the control board configuration menu setting 15 and the indoor blower operates. A 24VAC signal {sourced from LVTB 24VAC “R” and supplied through a user-provided Normally Open (NO) contact} activates (opens) the Motorized Damper and connected Relief Damper. When the 24VAC signal is removed, the motorized damper spring returns to the fully closed position and the indoor blower stops operation. The motorized damper Does NOT open when there is a call for the indoor fan (G).

Note: This circuit does not interrupt the compressor or heater operation.

Configuration “H”: GreenWheel® ERV Energy Recovery Ventilator (Optional)

Allows independent control of the exhaust and intake blowers. When used, the standard speed controller operates the intake blower and the optional second controller, the exhaust blower. Individual blower control allows positive pressurization of the classroom. Field or factory installed.

The Marvair GreenWheel® ERV is a total energy (both sensible and latent) wheel that reduces both construction and operating cost while ventilating the classroom to ASHRAE 62-1999 requirements. The use of the GreenWheel ERV reduces the energy load of the outside air. Exhausting stale, inside air keeps indoor pollutants and harmful gases to a minimum. The Marvair GreenWheel ERV has been tested and certified according to ARI Standard 1060.

How It Works: During the summer, cool dry air from the classroom is exhausted through the GreenWheel ERV to the outside. As the air passes through the rotating wheel, the desiccant becomes cooler and drier. Simultaneously, hot humid air is being pulled across the rotating wheel. The cool, dry desiccant absorbs moisture and heat from the incoming air. The cooler, drier air is mixed with the return air from the classroom and distributed throughout the room.

In the winter, warm moist air is exhausted through the GreenWheel ERV to the outside. As the air passes through the rotating wheel, the desiccant becomes warmer and absorbs moisture. Simultaneously, cold dry air is being pulled across the rotating wheel. The cold, dry air absorbs heat and moisture from the desiccant. The warmed air is mixed with the return air from the classroom and distributed throughout the room.

Quality Components: The GreenWheel ERV Ventilation package consists of the GreenWheel cassette, an incoming air blower, an exhaust air blower, an air filter for the incoming air and one fan speed controller that controls the speed of both blower motors simultaneously. As an option, a second fan speed controller can be factory installed for independent control of the exhaust air motor and positive pressurization of the classroom. Also, an optional filter on the exhaust air is available on selected models. Please consult your Marvair representative for details. The two blowers simultaneously pull fresh air from outside and exhaust air from the classroom through the rotating wheel. The air streams are separated by an insulated partition so that the incoming fresh air is not mixed with the exhaust air. Two variable speed blowers ensure that up to 450 CFM of outside air can be brought into the room and the indoor air is properly exhausted. Variable speed blowers permit that the desired quantity of outside air is delivered into the room. Optional independent exhaust air blower control allows positive pressurization of the classroom, i.e., more outside air can be introduced through the GreenWheel ERV than is exhausted.

Configuration “N”: Barometric Fresh Air Damper (Standard)

Barometric damper capable of up to 15% of rated airflow of outside air; field adjustable, no pressure relief.

Hot Gas Reheat (HGR) Dehumidification Mode (Special Option “G”)

When the HGR is in the dehumidification mode, the hot gas reheat (HGR) coil is energized. The cooled, dehumidified air exits the evaporator coil and is blown through the HGR coil. This coil is sized to the sensible capacity of the unit. The heat in the HGR coil is transferred to the air stream. The use of the HGR coil allows the indoor humidity of the classroom to be maintained at or below a certain set humidity set point without over cooling the classroom. These units can not add humidity to the classroom.

The operation of the HGR coil is controlled by a humidity controller. If the humidity rises above the set point on the controller and the temperature in the classroom is satisfied, both mechanical cooling and the HGR coil operate to temper the air and lower the humidity. If the temperature in the classroom rises above or falls below the set point of thermostat and the unit is operating in the dehumidification mode, the need for cooling or heating will override the call for dehumidification and the HGR coil is disengaged until the thermostat is satisfied. This assures the classroom temperature is maintained as first priority and humidity control is second.

The humidity controller or BAS control is required for proper operation of the HGR coil.

1.6 Options

Low Ambient Control

The low ambient control permits mechanical cooling when outdoor ambient temperatures are low. The control uses a reverse-acting high pressure switch to cycle the condenser fan motor according to liquid refrigerant pressure conditions. Switch closure and fan operation occurs when the pressure reaches 400 PSIG. The switch opens again when the refrigerant pressure falls to 245 PSIG. Therefore, the outdoor fan always starts after the compressor, **and it will cycle frequently during normal operation at low outdoor conditions.**

Hard Start Kit

Used on single phase equipment to give the compressor higher starting torque under low voltage conditions. Field installed only. (Not generally recommended for use on scroll compressor.)

Adjustable Outdoor Thermostat

Will not allow electric resistance heat to be energized unless the outdoor temperature is below the desired set point. Field or factory installed. Available on all Marvair units. P/N 93934

Single Point Feed

When multiple internal disconnects are used, single point feed permits only one field power supply to heat pump. Field installed only. Available on all Marvair H/P units.

Energy Management System (EMS)

Relay to control the heat pump. Available in 24, 120 or 240 VAC. Field or factory installed.

Electric Reheat for Dehumidification

Control provides simultaneous operation of compressor when in cooling mode and the electric elements to provide dehumidification without over cooling the room. The electric element (kW) must be properly sized for each model for proper operation. Factory installed. Available on all MAA units. Consult factory for details.

Hot Gas Reheat (HGR)

Marvair® heat pumps equipped with the Hot Gas Reheat (HGR) allow the indoor humidity of the controlled environment to be maintained at or below a certain humidity set point. These units do not have the ability to add humidity to the classroom.

Dehumidification is achieved by operating mechanical cooling in conjunction with a hot gas reheat coil. The coil is sized approximately to the sensible capacity of the total tonnage of the machine.

Speed Control for GreenWheel® ERV Exhaust Blower

For separate control of the exhaust blower. When used, the standard speed controller operates the intake blower and the optional second controller the exhaust blower. Individual blower control allows positive pressurization of the classroom. Can be factory or field installed.

Cabinet Color

Marvair heat pumps are available in six different cabinet colors. The standard colors are Marvair® beige, white, gray and Carlsbad Canyon (brown). The standard cabinet's sides, top and front panels are constructed of 20 gauge painted steel. Contact your Marvair representative for color chips. Custom colors are also available; contact Marvair for details.

Two stainless steel cabinet constructions are available:

Stainless Steel Exterior (Option “5”): This option replaces all standard exterior painted surfaces with stainless steel. This option also replaces the standard unpainted compressor base of the unit and exterior cabinet screws with stainless steel. No other standard construction surfaces are stainless steel in this option, unless listed in this description. Back panel is not stainless steel with this option. This option is designed to give a more economical alternative to full stainless steel, and still offer an enhanced level of protection. For further corrosion protection, please see our “A” offering at full stainless on all metal components.

Stainless Steel Unit (Option “A”): This option replaces all interior and exterior steel sheet metal parts with stainless steel. All galvanized and painted steel surfaces found in the standard unit are stainless steel with this option. All cabinet screws are stainless steel. No other standard construction surfaces are stainless steel, unless listed in this description. This option is designed to give our most robust protection against steel corrosion.

Chapter 2 Electronic Control Board

2.1 Introduction



WARNING

Failure to observe the instructions contained in this document may result in personal injury and/or property damage and may void the warranty. Read this manual before installing, replacing or using this product.

Marvair's proprietary Printed Circuit Board (PCB) sets the standard for the industry in flexibility, reliability and performance. This UL certified component is engineered to optimize Heating, Cooling and Dehumidification operation while communicating valuable information to the end user. Special features include 2-Stage operation with varying speed control to optimize latent and sensible capacity, built in remote communication (Modbus) for monitoring and/or control, optimized head pressure control and configurable menu options for various operations and control. The Marvair PCB comes equipped with seven segment display to annunciate faults, which drastically reduces troubleshooting time and system downtime. Lockout contacts are also provided along with the alarms being transferred via Modbus.

This chapter provides the necessary information for installing and operating the Marvair PCB. The diagram below identifies the inputs, outputs and connections for the Marvair PCB. See I/O table.

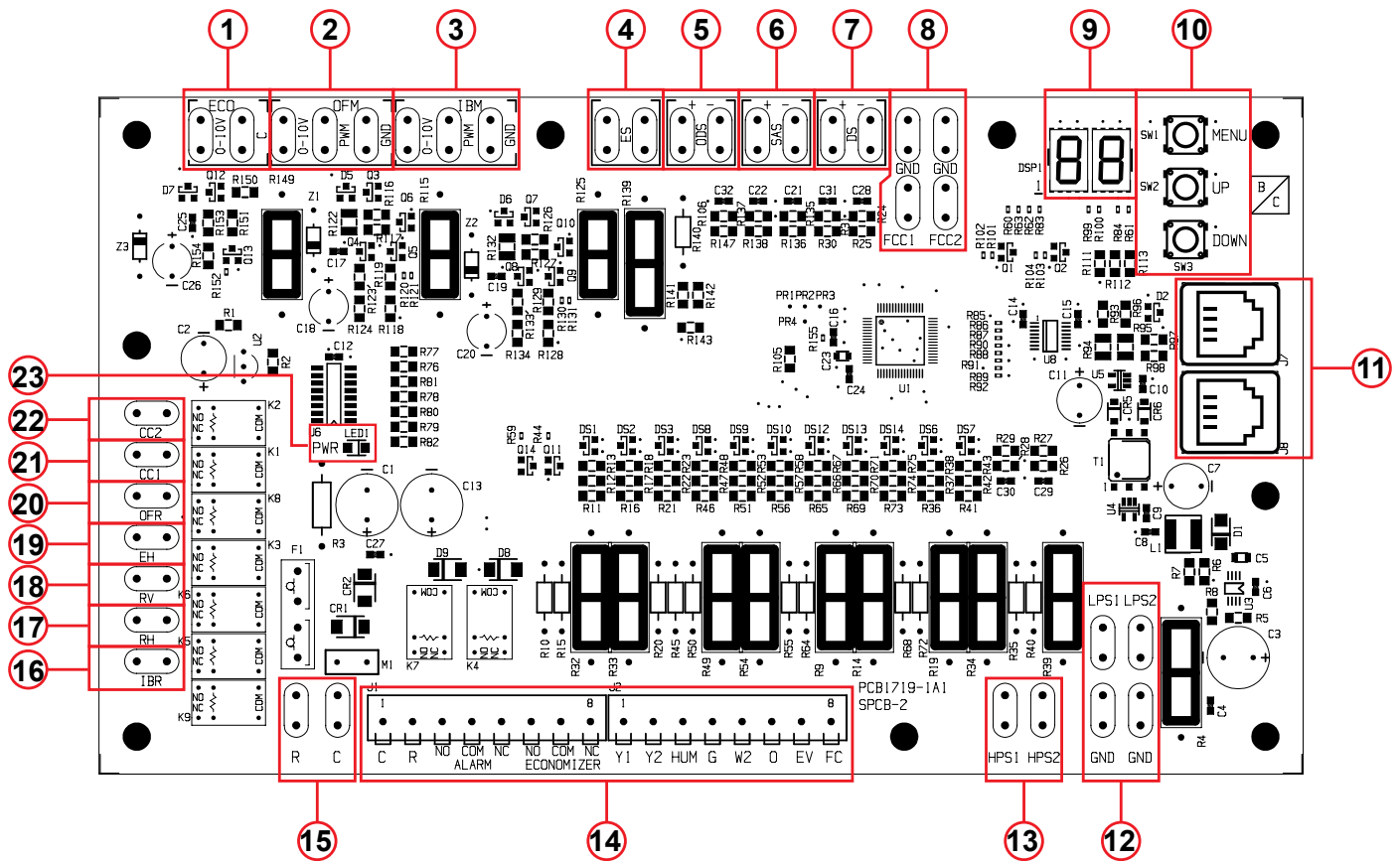

I/O Table for Control Board	
Item	Description
1	Economizer Actuator Output 2-10 VDC
2	Outdoor Motor Control Output 0-10 VDC or PWM
3	Indoor Motor Control Output 0-10 VDC or PWM
4	Enthalpy Sensor Signal Input 4-20mA
5	Outdoor Sensor Signal 10K NTC (Heat Pumps) / Dry Bulb Sensor Signal Input 10K NTC (Systems Equipped with Dry Bulb Economizer)
6	Supply Air Sensor Signal Input 10K NTC (Systems Equipped with Economizer)
7	Defrost Sensor Signal Input 10k NTC (Heat Pumps Only)
8	Head Pressure Control Sensor Signal 10k NTC (ECM Motors)
9	Control Board Menu/Fault Display
10	Menu/Up/Down Selection Buttons
11	Modbus RJ11 Communications Ports
12	Low Pressure / Freeze Sensor Signal Input 10k NTC
13	High Pressure Switch Input (Normally Closed)
14	Thermostat Inputs/Alarm And Status Terminals
15	24 VAC To Power Board (18 VAC To 30 VAC)
16	Indoor Blower Output 24 VAC (PSC Motors)
17	Reheat Output 24 VAC (Hot Gas Or Electric Reheat Dehumidification)
18	Reversing Valve Output 24 VAC (Heat Pumps Only)
19	Electric Heat Output 24 VAC
20	Outdoor Fan Output 24 VAC (PSC Motors)
21	Compressor 1/1st Stage Output 24 VAC (Single Stage Compressor)
22	Compressor 2/2nd Stage Output 24 VAC (Dual Compressor System 2nd Compressor) (Single Compressor 2nd Stage)
23	Control Board Power Indicator LED

2.2 Installation and Replacement

The PCB is factory installed. To install a replacement PCB, use the six mounting holes along with the appropriate screw size to firmly secure the board to the control box. After this is achieved, follow the wiring diagram and menu configuration for the respective system for appropriate operation. Ensure that the terminals used do not make any unwanted electrical connection (via strands etc.) with any other terminals. Please allow a 1” creepage distance between the board and all other adjacent electrical components.

2.3 PCB Details and Information

The PCB is equipped with an on board seven-segment display (Item #9) for configuring various settings and displaying faults. During normal operation the display remains off unless the configuration menu is accessed or a fault has occurred. Faults will be annunciated on the display as shown below:



Display	Displayed Faults
AS-F	Supply Air Sensor Fault (Sensor Disconnected Or Faulty) If Equipped
DB-F	Dry Bulb / Outdoor Sensor Fault (Sensor Disconnected Or Faulty) If Equipped
DS-F	Defrost Sensor Fault (Sensor Disconnected Or Faulty) Heat Pumps Only
ES-F	Enthalpy Sensor Fault (Sensor Disconnected Or Faulty) If Equipped
EF	Emergency Fan / Ventilation Active
Lc	Loss of Refrigerant / Flat Unit Fault
LP-1	Low Pressure Lockout Compressor Circuit 1
LP-2	Low Pressure Lockout Compressor Circuit 2
HP-1	High Pressure Lockout Compressor Circuit 1
HP-2	High Pressure Lockout Compressor Circuit 2
03	Low Voltage "Brownout" 16VAC or Less for 10 Minutes

2.3.1 – Programming Menu Configuration

1. To Enter Programming Mode:
 - Press and hold the *Menu* button for 5 seconds until **P-01** is displayed.
2. While in Programming Mode main menu:
 - Press the *Menu* button to enter the displayed parameter menu.
 - Press the Up/Down buttons to adjust the current parameter number.
 - The current parameter number will be displayed seven segments alternating showing "P-" and the number every 0.5s.
3. While in parameter menu:
 - The current parameter selection will be displayed seven segments.
 - Press the *Menu* button to save the current parameter selection return to the programming main menu.
 - Press the Up/Down buttons to adjust the current parameter selection.
4. To exit programming mode, press and hold the *Mode* and *Up* buttons while in the programming main menu.
 - Press and hold the *Menu* button for 5 seconds.
 - **Note:** The control will automatically exit the programming mode after 2 minutes with no activity.

Note: 100 will be displayed by alternating between "1" and "00" every 0.5s.

Configuration Menu				
Menu Setting	Name	De-fault	Selections	General Description
1	AC/HP Select	AC	AC, HP	HP = Heat Pump Unit, AC = AC Unit
2	IBM Select	P	P, dC	P = PWM, dC = 0-10V
3	FAN PURGE	90	N, 10-90	Indoor Blower off delay in seconds
4	IBM Y1 Set	80	40-100	"G" Fan only and "Y1" 1st Stage Cooling Indoor Blower Speed Setting
5	IBM Y2 Set	100	40-100	"Y2" 2nd Stage Cooling Indoor Blower Speed Setting
6	OFM Select	P	P, dC	P = PWM, dC = 0-10V
7	OFM Set	80	65-100	Outdoor Fan Motor Max Speed setting
8	Defrost Timer	30	30, 60, 90	Defrost cycle timer in minutes
9	EHDD select	Y	Y, n	CAN ONLY BE "Y" IF SCKT IS "N"
10	SCKT select	n	Y, n	SCKT= Y OVERRIDES EHDD
11	ODS set	50	0-70	Outdoor Sensor for HP or Econo. Dry Bulb Setpoint
12	ECONO select	n	Y, n	n = Disabled (No Econo.), Y = Enabled (W/Econo.)
13	Sensor Type	EN	EN or DB	Economizer sensor type selection EN= Enthalpy, DB = Dry Bulb
14	ECONO set	d	A-E	Selections A=73F, B=70F, C= 67F, D =63F E= 55F all @ 50%RH (Only available if EN sensor type is se-lected)
15	MIN POS	20	20-100	Sets the damper position for Minimum Open
16	W2 speed	100	70-100	Sets the Indoor Blower Speed for Electric Heat
17	Dehum speed	80	60-100	Sets the Indoor Blower Speed for Dehumidification
18	Pulse Reheat	Y	n/Y	Y = Pulsing reheat @ Dehum Supply Set N= On/Off rheat
19	Dehum Supply Set	72	70-75	Supply Air Setpoint for Dehumidification w/ 5°F Off Differential
20	DS calibration	0	-18	Defrost Sensor Calibration
21	SAS calibration	0	-18	Supply Air Sensor Calibration
22	T'STAT Select	H	H, C	H = hardwired 24V Tstat, C = communicating Tstat
23	Modbus ID	1	36161	Sets the Modbus ID for the unit
24	Modbus BAUD rate	19	9.6, 19	Available Baud Rates 9.6 = 9600, 19 = 19200
25	Modbus timeout	25	21916	Communications Timeout in minutes
26	Test	n	Y, n	When set to "Y" all timers are reduced for testing
27	SW version number	N/A	N/A	Displays the current version software

Configuration Menu Details

1. **AC/HP Select:** This setting allows the PCB to be configured for AC (air-conditioner) or HP (heat-pump). The system type is configured at the factory during production testing for the appropriate system type. The default system type is AC.
2. **IBM Select:** This setting allows the IBM (Indoor Blower) control signal to be configured for PWM or 0-10vdc control. The default control output signal is PWM.
3. **Fan Purge:** This setting allows the delay off time of the indoor blower once the call for the indoor blower has been removed. The selections are N (no delay) or 10-90 seconds. After the default time of 90 seconds the indoor blower will shut off. Selecting the N (no delay) will allow the Indoor blower to shut off immediately after any request has been removed.
4. **IBM Y1 Set:** This is an independent setting for the speed at which the Indoor blower will operate upon a request for Y1 (1st stage cooling) via Digital Input or Modbus. The default setting for the IBM Y1 Set is 80% of maximum speed. The speed may be adjusted from 40-100% in 1% increments to meet desired airflow requirements. Note: Adjusting the speed too low will result in coil freezing.
5. **IBM Y2 Set:** This is an independent setting for the speed at which the Indoor blower will operate upon a request for Y2 (2nd stage cooling) via Digital Input or Modbus. The default setting for the IBM Y1 Set is 100% of maximum speed. The speed may be adjusted from 40-100% in 1% increments to meet desired airflow requirements.

Note: Adjusting the speed too low will result in coil freezing, low-pressure or high-pressure lockout.

6. **OFM Select:** This setting allows the IBM (Indoor Blower) control signal to be configured for PWM or 0-10vdc control. The default control output signal is PWM.
7. **OFM Set:** This is an independent setting for the max speed at which the Outdoor fan will operate. The default setting for the OFM Set is 80% of maximum speed. The speed may be adjusted from 65-100% in 1% increments to meet desired airflow requirements.

Note: Adjusting the speed too low will result in coil freezing, low-pressure or high-pressure lockout.

8. **Defrost Timer:** The defrost timer only applies to Heat-pump systems (when setting 1 is set to HP). This is the accumulation timer used to monitor for heat-pump defrost control. The selections for defrost timing is 30, 60 and 90 minutes. The defrost timer accumulates the compressor runtime in the heat-pump mode and monitors the defrost sensor for freezing conditions to initiate a defrost cycle at the selected defrost timing interval. The default defrost time is 30 minutes.
9. **EHDD Set:** The Electric heat during defrost setting allows the electric heat to operate when a defrost cycle is being performed in heat-pump mode. The selections for the EHDD Set are Y (yes) or N (no). When set to N (no) the electric heat will not operate automatically during a defrost cycle in heat-pump mode. When the EHDD Set is set to Y (yes, Default) the electric heat will operate upon each defrost cycle in the heat-pump mode.

Note: EHDD and SCKT cannot both be set to the Y (yes) selection at the same time. SCKT takes priority over EHDD.

10. **SCKT Set:** The SCKT setting is used to prevent simultaneous operation of the electric heat and compressor. The selections for the SCKT Set are Y (yes) or N (no). When set to N (no, Default) the electric heat will be allowed to operate with the compressor in heat-pump mode upon a call for W2 (auxiliary / emergency heat). When the SCKT Set is set to Y (yes) the electric heat will not be allowed to operate with the compressor in the heat-pump mode. When set to Y (yes) and upon a request for W2 (auxiliary / emergency heat) the compressor will shut off and the electric

heat will operate.

Note: SCKT and EHDD cannot both be set to the Y (yes) selection at the same time. SCKT takes priority over EHDD.

11. ODS Set: The ODS Set is used to set the Outdoor Sensor temperature for Heat-pump systems. When the system type is configured for Heat-pump (when setting 1 is set to HP), the ODS Set allows the outdoor sensor to be used to govern when electric heat is allowed to operate. When the outdoor temperature is below the ODS setpoint, the electric heat will be allowed to operate. The adjustable range is 0°F-70°F in 1F increments with a default setpoint of 50°F.

12. ECONO Select: The ECONO Select is used to select whether the system has an economizer system installed or not. When set to the Y (yes) selection the system will include the economizer cooling algorithm within its sequence of operation and utilize the economizer package when conditions are favorable for economizer cooling. When set to the N (no) selection the system will only utilize the compressor for cooling operation. This setting is configured at the factory during production testing for the appropriate system type.

Note: When ECONO Set is set to Y (yes) the system must have an Enthalpy or Dry Bulb and Supply Air sensor connected and properly selected in setting 13 in order to operate in economizer cooling. The system will default to compressor cooling if any sensor becomes disconnected or faulty. Changing the ECONO Select to N (no) will disable economizer operation and the economizer function will be ignored.

13. Sensor Type: This setting is used for selecting the type of economizer sensor used EN (Enthalpy) or DB (Dry Bulb). The appropriate sensor must be connected and selected for economizer operation. This setting is configured at the factory during production testing for the appropriate sensor type.

14. ECONO Set: This setting is used to set the economizer setpoint at which the economizer is allowed to operate for cooling. When setting 13 is set for EN (Enthalpy), the selections are A=73°F, B=70°F, C=67°F, D=63°F and E=55°F all at 50% relative humidity. The A – E selections will only be available when setting 13 is set to EN (Enthalpy). When setting 13 is set for DB (Dry Bulb), the selection is from 20°F to 105°F in 1F increments. The 20°F-105°F range will only be available when setting 13 is set to DB (Dry Bulb).

15. MIN POS: The MIN POS setting is for setting the minimum position of the economizer or motorized damper. When set above 20 (2vdc) the damper will remain open to the selected position at all times, hence minimum position. The adjustable range is from 20 (2vdc) to 100 (10vdc) in 1vdc increments.

16. W2 Speed: This is an independent setting for the speed at which the Indoor blower will operate upon a request for W2 (Electric heat) via Digital Input or Modbus. The default setting for the W2 speed is 100% of maximum speed. The speed may be adjusted from 70-100% in 1% increments to meet desired airflow requirements.

Note: Adjusting the speed too low will result in increased supply air temperatures in electric heat mode.

17. Dehum Speed: This is an independent setting for the speed at which the Indoor blower will operate upon a request for HUM (Dehumidification) via Digital Input or Modbus. The default setting for the Dehum speed is 80% of maximum speed. The speed may be adjusted from 60-100% in 1% increments to meet desired airflow requirements.

18. Pulse Reheat: This setting allows the dehumidification output “RH” to be cycled On and OFF based on the Dehum Supply temperature setpoint. The Options are Y= Yes or N= No and the default is Y.

19. **Dehum Supply Set:** This setting allows the target setpoint for the supply air temperature during dehumidification operation. The setpoint range is adjustable from 70F to 75F with a fixed differential of 5F. The default setpoint is 72°F
20. **DS Calibration:** This setting is used to calibrate the defrost sensor from 0° to -18°F.
21. **SAS Calibration:** This setting is used to calibrate the supply air sensor from 0° to -18°F.
22. **T'STAT Select:** The thermostat type can be selected with this setting for an option of H= Hardwired 24vac Thermostat or C = Communicating Thermostat via Modbus. The default setting is H= Hardwired 24vac Thermostat.
23. **Modbus ID:** This setting allows the Modbus ID to be entered for Modbus communications for the unit. The range for the Modbus ID is 1 – 36161 the default Modbus ID is 1.
24. **Modbus Baud Rate:** This setting allows the Modbus Baud Rate to be entered for Modbus communications. The available Baud Rates are 9.6= 9600 and 19= 19200. The default Modbus Baud Rate is 19 = 19200.
25. **Modbus Timeout:** This is the setting for the Modbus communications timeout in minutes. The range of communications timeout is from 25 minutes to 21916 minutes. The default communications timeout is 25 minutes.
26. **Test:** The Test feature has two options Y= Yes or N= No. When this setting is set to Y=Yes, all circuit timers are reduced to expedite testing for various system operations. When set to N=No, all circuit timers are used in their default configuration and normal operation.
27. **Software Version Number:** The software version of the 92589-control board will be displayed on the seven-segment display. This is for informational purposes only.

2.4 Operation

Power

The Marvair PCB requires 24 VAC to operate. When the board is sufficiently powered, the “PWR” status light on the PCB illuminates “Green.” When the power supply voltage is 16vac or less for 10 seconds the control board will de-energize all outputs. This is considered a voltage brownout (low voltage) condition and the display of the control board will show “03” as an indicator of brownout (low voltage). When the voltage rises back to 17 VAC, the control board will allow the system to operate.

Note: The nominal power supply for the control board is 24 VAC and this voltage should be confirmed during startup to assure normal operation.

Communication

The Marvair PCB comes equipped the Modbus communications standard. There are 2 adjacent RJ11 Modbus communication ports connected in parallel. That is, both ports transmit the same information. The board allows you to set the Baud Rate at 9600 bits per second or 19200 bits per second. The board also allows the Modbus ID to be selected in the configuration menu with the available range from 1 to 36161. The default Modbus ID is 1. *See section 2.1 for reference.*

2.5 Sequence of Operation

All equipment should go through the recommended commissioning/start up sequence to ensure safety and system reliability. This document is only valid if the system is used as intended.

This section defines the manner and method of control of the HVAC system. It will cover the following operations and protections.

1.0 Indoor Blower Operation

- 1.1 G - Indoor Blower Only
- 1.2 Y1 - Indoor Blower Operation
- 1.3 Y2 - Indoor Blower Operation
- 1.4 W2 – Indoor Blower Operation
- 1.5 HUM – Indoor Blower Operation

2.0 Cooling Operation AC / HP

- 2.1 Mechanical Cooling (AC systems)
 - 2.1.1 Partial Capacity
 - 2.1.2 Full Capacity
- 2.2 Mechanical Cooling (HP systems)
 - 2.2.1 Partial Capacity
 - 2.2.2 Full Capacity

3.0 Economizer Operation

- 3.1 Enthalpy Sensor and Operation
- 3.2 Dry Bulb Sensor and Operation
- 3.3 Supply Air Sensor
- 3.4 Minimum Position

4.0 Heating Operation AC / HP

- 4.1 Electric Heat (AC systems)
- 4.2 Heat Pump Heating Operation
- 4.3 Defrost Operation (Heat Pumps)
- 4.4 Electric Heat / Outdoor Sensor / SCKT / EHDD (Heat Pumps)

5.0 Dehumidification Operation AC / HP

- 5.1 Hot Gas Reheat
- 5.2 Electric Reheat
- 5.3 Pulse Reheat

6.0 Refrigeration Protection

- 6.1 High Pressure lockout
- 6.2 Low Pressure Lockout / Freeze Protection
- 6.3 Anti Short Cycle
- 6.4 Loss of Charge / Flat Unit Fault

7.0 Additional Features

- 7.1 Modulating Head pressure Control (ECM Outdoor Motors)
- 7.2 Emergency Ventilation
- 7.3 Forced Cooling
- 7.4 Modbus Communications
- 7.5 Low Voltage (Brownout)

8.0 Smoke / Fire Shutdown

- 8.1 System Shutdown Contact Wiring

Note: Equipment, devices and necessary system components are specified in the respective section.

Note:

- 1. All inputs on the control board go through a 5 seconds Time-On Delay to prevent nuisance request. Compressor Outputs go through 5 seconds staggered Time On delay to prevent nuisance tripping of breaker due to the inrush associated with these large inductive loads.
- 2. Normal Operating Mode describes a mode in which there are no active faults which would interrupt the operation of the system.

1.0 Indoor Blower Operation

The speed at which the indoor blower will operate is based on the discrete operational inputs that have 24vac applied. These inputs are listed below.

- 1.1 G Input** – A request for Fan Only (independent G-signal via Digital input or Modbus), results in the indoor motor turning “ON” and operating at the “Y2” (BY DEFAULT) motor speed (Only Applicable for EC motors).
- 1.2 Y1 Input** – A request for Y1 (independent Y1-signal via Digital input or Modbus), results in the indoor motor turning “ON” and operating at the “Y1” motor speed (Only Applicable for EC motors).
- 1.3 Y2 Input** – A request for Y2 (independent Y2-signal via Digital input or Modbus), results in the indoor motor turning “ON” and operating at the “Y2” motor speed (Only Applicable for EC motors).
- 1.4 W2 Input** – A request for W2 (independent W2-signal via Digital input or Modbus), results in the indoor motor turning “ON” and operating at the “W2” motor speed (Only Applicable for EC motors).
- 1.5 HUM Input** – A request for HUM (independent HUM-signal via Digital input or Modbus), results in the indoor motor turning “ON” and operating at the “HUM” motor speed (Only Applicable for EC motors).

When there is a request for Indoor Fan (G-input High) along with a request for cooling, heating or dehumidification, the G-Input becomes lowest priority. This means that in any combination involving the G-input, the speed associated to Fan Only will never take precedence.

The priority list from Highest to Lowest goes as follows:

1. Y2 - Request
2. Y1 - Request
3. W2 - Request
4. HUM - Request
5. G - Request

Note: The priority list above also describes the operation that takes precedence in the event that there is a request for all operations or a combination of operations. The controller will NOT energize the compressor outputs and the heater output simultaneously if configured for AC. The controller WILL energize the compressor outputs and the heater output simultaneously if configured for HP.

The speed at which the Indoor Fan Operates during Stage 1 (Y1) and Stage 2 (Y2) Cooling Request can be set directly at the board using the configuration menu settings 4 and 5. All requests are interlocked with the Indoor Fan and will run the Fan at the respective speed associated with the operation. This means that a lone call for Stage 1 (Y1) Cooling will automatically run the Indoor Fan at Stage 1 (Y1) Cooling Speed even without a request for Indoor Fan. This holds true for all request.

2.0 Cooling Operation

AC Systems Request	Active Input	Active Output
Stage 1 Cooling (Fixed Compressor)	Y1	CC1 (Partial Capacity)
Stage 1 Cooling (2 Fixed Compressors)	Y1 or Y2	CC1 or CC2 Respectively (Partial Capacity)
Stage 1 Cooling (1 Staged Compressor)	Y1	CC1 (Partial Capacity)
Stage 2 Cooling (2 Fixed Compressors)	Y1 + Y2	CC1 + CC2 (Full Capacity)
Stage 2 Cooling (2 Staged Compressors)	Y1 + Y2	CC1 + CC2 (Full Capacity)

2.1 Mechanical Cooling (AC systems) – This section will describe the sequence of operation which takes place during Direct Expansion (DX) cooling from a control standpoint.

Note: The system type must be configured for “AC” operation in setting 1 of the configuration menu of the control board for proper AC system operation. This system type is selected at the factory and there’s no need to change this setting.

2.1.1 Y1 Cooling (Partial Capacity 1st Stage) – In normal operating mode, a request for “Stage1 Cooling” Y1-signal via Digital input or Modbus), energizes Compressor 1 Relay Output (CC1) on the PCB. The controller provides a continuous control signal associated to the Indoor Fan Motor, that is proportional to the “Y1” speed setting on the board or via Modbus. It also outputs a request dependent (based on FCC IN) control signal for the Outdoor Fan Motor (Only applicable to ECM motors). In Stage 1 Cooling operation, the compressor operates at partial capacity and the indoor fan remains on continuously but the outdoor fan modulates based on liquid line temperature. The Fan Cycle Control Sensor (Low Ambient Control Sensor) monitors the liquid line to maintain a 90F liquid line temperature. When the liquid line temperature is below 80F the outdoor fan will shut off. A liquid line temperature above 115F will force the outdoor fan to operate at the maximum speed set on the control board for setting 7 in the configuration menu. The outdoor fan will speed up and slow down between liquid line temperature of 80F and 115F. Systems with (PSC Outdoor Motors) utilizes a Fan Cycle Switch which closes at 400 PSIG to energize the OFR (outdoor fan relay) to start the outdoor fan which runs until the switch reopens (at 290 PSIG). These outputs function as described until the Cooling setpoint is satisfied. This is considered as ON/OFF fan cycle control and the PSC motor will not modulate.

Note: Single Stage compressors operate at full capacity upon a request for Y1.

2.1.2 Y1 and Y2 Cooling (Full Capacity 2nd Stage) – If the space temperature continues to increase pass the defined differential, Stage 2 Cooling (Y2-input) is energized. Under normal operation, this energizes the Compressor 2 Output (CC2). The Indoor Fan motor, will operate at “Y2” speed instead of “Y1” speed since Y2 has higher priority. These outputs remain energized until the cooling setpoint is satisfied. Once the setpoint is satisfied, the Compressor and the Outdoor fan outputs are de-energized. The Indoor motor continues to run based on the fan purge timer setpoint (default 90 seconds) selected in setting 3 of the configuration menu of the control board.

Note: 2 Stage compressors require a request for Y2 to operate at full capacity in Cooling operation. All Air-conditioners and Heat Pump systems with 2 stage compressors are allowed 2 stage cooling operation.

2.2 Mechanical Cooling (HP systems) – This section will describe the sequence of operation which takes place during Direct Expansion (DX) cooling from a control standpoint. The reversing valve (O Input) must be energized for Cooling operation on Heat Pump systems.

Note: The system type must be configured for “HP” operation in setting 1 of the configuration menu of the control board for proper HP system operation. This system type is selected at the factory and there’s no need to change this setting.

2.2.1 Y1+ O Cooling (Partial Capacity 1st Stage) – In normal operating mode, a request for “Stage1 Cooling” Y1 + O signal via Digital input or Modbus), energizes the Reversing Valve Output (RV) and Compressor 1 Relay Output (CC1) on the PCB. The controller provides a continuous control signal associated to the Indoor Fan Motor, that is proportional

to the “Y1” speed setting on the board or via Modbus. It also outputs a request dependent (based on FCC IN) control signal for the Outdoor Fan Motor (Only applicable to ECM motors). In Stage 1 Cooling operation, the compressor operates at partial capacity and the indoor fan remains on continuously but the outdoor fan modulates based on liquid line temperature. The Fan Cycle Control Sensor (Low Ambient Control Sensor) monitors the liquid line to maintain a 90F liquid line temperature. When the liquid line temperature is below 80F the outdoor fan will shut off. A liquid line temperature above 115F will force the outdoor fan to operate at the maximum speed set on the control board for setting 7 in the configuration menu. The outdoor fan will speed up and slow down between liquid line temperature of 80F and 115F. Systems with (PSC Outdoor Motors) utilizes a Fan Cycle Switch which closes at 400 PSIG to energize the OFR (outdoor fan relay) to start the outdoor fan which runs until the switch reopens (at 290 PSIG). These outputs function as described until the Cooling setpoint is satisfied. This is considered as ON/OFF fan cycle control and the PSC motor will not modulate.

Note: Single Stage compressors operate at full capacity upon a request for Y1.

2.2.2 Y1 + Y2 + O Cooling (Full Capacity 2nd Stage) – If the space temperature continues to increase pass the defined differential, Stage 2 Cooling (Y1+Y2+O input) is energized. Under normal operation, this energizes the Compressor 2 Output (CC2). The Indoor Fan motor, will operate at “Y2” speed instead of “Y1” speed since Y2 has higher priority. These outputs remain energized until the cooling setpoint is satisfied. Once the setpoint is satisfied, the Compressor and the Outdoor fan outputs are de-energized. The Indoor motor continues to run based on the fan purge timer setpoint (default 90 seconds) selected in setting 3 of the configuration menu of the control board.

Note: 2 Stage compressors require a request for Y2 to operate at full capacity in Cooling operation. All Air-conditioners and Heat Pump systems with 2 stage compressors are allowed 2 stage cooling operation.

Note: With staged compressors, a CC2 output without a CC1 output will neither result in partial capacity nor full capacity. Only CC1 output can achieve partial capacity. Both CC1 and CC2 outputs are required to achieve full capacity.

3.0 Economizer Operation (If Equipped)

Damper Actuator

The damper actuator is a 24V motor that modulates the position of the damper blade. It is capable of driving a full 90 degrees within 90 seconds. The assembly has a spring return to close the damper during power outage.

3.1 Enthalpy Sensor and Operation – The enthalpy sensor responds to the total heat content of the outdoor air to provide the changeover to outside air for free cooling. The control board must be configured for proper operation of the economizer by selecting Y= Yes in the configuration menu setting 12. The sensor type must be selected in setting 13 for EN=Enthalpy. The desired changeover setpoint must be selected in setting 14 (default D=63F@50% rh). Example of Enthalpy Sensor and Enthalpy curve is shown below.

Note: Selecting N=No in configuration setting 12 will disable economizer operation.



Sever hazard. The economizer contains moving parts capable of causing serious injury or death. Disconnect power before removing the covering panel.



Enthalpy Setpoint is Setting 14 in control board configuration menu.

Options

- A= 73°F
- B= 70°F
- C= 67°F
- D= 63°F
- E= 55°F

All settings are @ 50%Rh

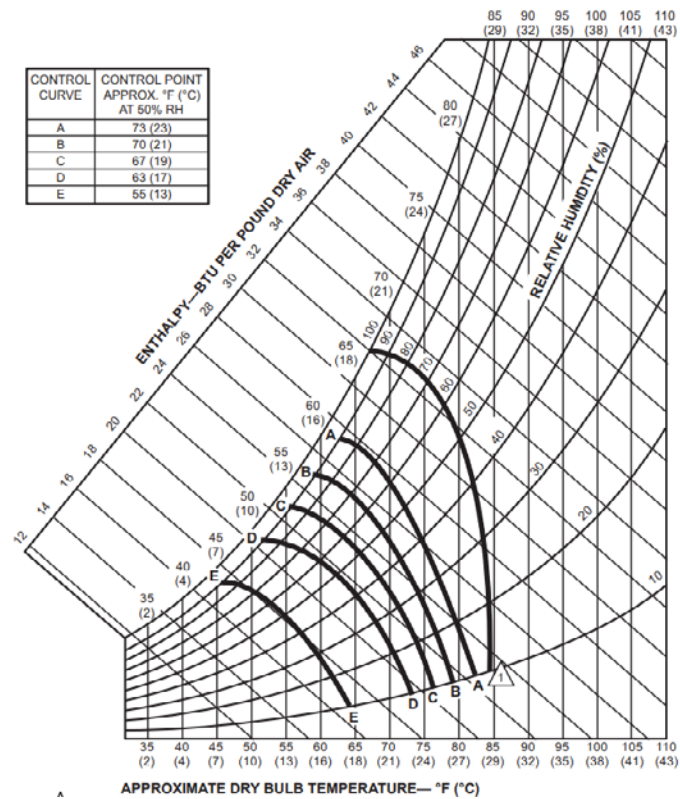

Figure 2. Enthalpy Sensor & Temperature Control Points

Enthalpy Operation

On a call for cooling from the wall-mounted thermostat, if outdoor conditions are suitable, the sensor will open the damper and admit outside air (i.e., economizer free cooling). If the outdoor ambient is too hot or humid (enthalpy sensor only), the sensor will place the actuator in the closed or minimum open position and activate mechanical cooling. The compressor is locked-out during the economizer cooling mode. The Supply Air sensor monitors the supply air of the system in economizer mode to modulate the economizer damper to maintain a 55F supply air temperature.

During the testing of the air conditioner at the factory, the control board has been configured for the sensor type used in the system. There should be no need to change the sensor configuration. If an enthalpy sensor is being used, setting 13 of the control board configuration menu will be set for EN= Enthalpy. A disconnected or faulty enthalpy sensor is annunciated on the control board display as “ES-F”. Economizer operation is only allowed in Cooling Mode.

Note: A call for Y2 or FC Inputs or a faulty or disconnected enthalpy sensor will override the economizer operation and force the compressor to operate.

3.2 Dry Bulb Sensor and Operation – The dry bulb sensor only responds to the dry bulb temperature of the outside air and ignores the humidity. The sensor is a 10K NTC sensor probe. The factory setting is 63°F. This setpoint can be adjusted in 1F increments from 20F to 105F in the control board configuration menu setting 14. Example of the dry bulb sensor is shown below.

Note: Selecting N=No in configuration setting 12 will disable economizer operation.



Figure 3. Dry Bulb Sensor

On a call for cooling from the wall-mounted thermostat, if outdoor conditions are suitable, the sensor will open the damper and admit outside air (i.e., economizer free cooling). If the outdoor ambient is too hot (dry bulb sensor only), the sensor will place the actuator in the closed or minimum open position and activate mechanical cooling. The compressor is locked-out during the economizer cooling mode. The Supply Air sensor monitors the supply air of the system in economizer mode to modulate the economizer damper to maintain a 55F supply air temperature.

During the testing of the air conditioner at the factory, the control board has been configured for the sensor type used in the system. There should be no need to change the sensor configuration. If a dry bulb sensor is being used, setting 13 of the control board configuration menu will be set for

DB=Dry Bulb. A disconnected or faulty dry bulb sensor is annunciated on the control board display as “db-F”. Economizer operation is only allowed in Cooling Mode.

Note: A call for Y2 or FC Inputs or a faulty or disconnected dry bulb sensor will override the economizer operation and force the compressor to operate.

3.3 Supply Air Sensor – The supply air sensor is a 10K NTC sensor probe mounted on a bracket in the supply air opening of the system. The probe senses the air temperature entering the structure, and provides a signal to the economizer controller for modulating the position of the damper. The default supply air temperature is 55F in economizer cooling and is not adjustable. A disconnected or faulty supply air sensor is annunciated on the control board display as “AS-F”.

Note: A faulty or disconnected supply air sensor will override the economizer operation and force the compressor to operate.

3.4 Minimum Position – The minimum position controls the amount of outside air introduced in the building when not in economizer operation or to meet a minimum outside air requirement to keep the damper open. This feature is only applicable to systems with economizer or ventilation damper options. The minimum position can be adjusted in the control board configuration menu with setting 15. The setpoint adjustments are from 20 (2vdc) to 100 (10vdc) in 1vdc increments. This is an independent adjustment and can be set to drive the ventilation damper open to any position from closed to fully opened. A selection of 20 (2vdc) is the same as being set to OFF or fully closed.

4.0 Heating Operation

4.1 Electric Heat (AC Systems with Electric Heat) – When there is a request for “Electric Heat” (W2-signal via Digital input or Modbus), the system will run the Indoor Motor for 10 seconds prior to energizing the Heater Output. The Indoor Motor will operate at the “W2” speed setting on the board or via Modbus. Once the Heater output is energized, the Heater comes on at full capacity (no staging). The Heater will remain on until the Heating setpoint is satisfied and the request is dropped. Once the heating setpoint is satisfied, the Indoor motor continues to run based on the fan purge timer setpoint (default 90 seconds) selected in setting 3 of the configuration

menu of the control board.

Note: A request for Cooling and Heating at the same time is not allowed and control board will not allow the electric heat to operate.

4.2 Heat Pump Heating Operation – This section will describe the sequence of operation which takes place during Direct Expansion (DX) heating from a control standpoint. The reversing valve (O Input) must NOT be energized for Heating operation on Heat Pump systems.

Note: The system type must be configured for “HP” operation in setting 1 of the configuration menu of the control board for proper HP system operation. This system type is selected at the factory and there’s no need to change this setting.

In normal operating mode, a request for “Heat Pump Heating” Y1 signal via Digital input or Modbus), energizes the Compressor 1 and 2 Relay Output (CC1+CC2) on the PCB. The controller provides a continuous control signal associated to the Indoor Fan Motor, that is proportional to the “Y2” speed setting on the board or via Modbus. The system is defaulted to operate at Full capacity in heat pump heating mode. It also outputs a request for the Outdoor Fan to operate at the max speed. In heat pump Heating operation, the compressor operates at Full capacity and the indoor and outdoor fans remain on continuously. The outdoor fan does not modulate in heat pump heat mode.

4.3 Defrost Operation (Heat Pump Systems Only) – The board has an integral accumulation run timer that runs on every request for heat pump heating. The system has a Defrost Sensor (DS) that monitors the outdoor coil circuit for freezing conditions. If the defrost sensor registers a temperature of 32°F while in the heat pump heating mode, it will initiate a defrost cycle based on the time selected in the control board configuration menu setting 8. The defrost time intervals selections are 30, 60 and 90 minutes and the factory default setting is 30 minutes. If the defrost sensor is still calling for defrost at the end of this delay, it will de-energize the outdoor fan, energize the reversing valve through the RV terminal, and keep the compressor energized. The defrost cycle will terminate on time or temperature. It will have a maximum defrost run time of 10 minutes, however, if the defrost sensor registers a temperature of 70°F or higher before the 10-minute maximum run time, the defrost cycle will terminate. If the defrost cycle has not completed (DS sensor above 70F) due the heating call being satisfied, the defrost cycle will continue upon the next call for heat pump heating to complete the defrost cycle. If freezing conditions are not present at the end of the defrost interval timer, the system will not perform a defrost cycle.

Note: If the DS sensor is disconnected or faulty, the compressor will not operate in heat pump heating mode and the control board display will annunciate the fault as “DS-F”.

Note: If “Yes” has been selected for Electric Heat During Defrost (EHDD) and “No” selected for the SCKT, the electric heat (EH) output will be energized during a defrost cycle to supply heat while the coil defrosts. *If the ODS is used, the electric heat will operate only if the outdoor temperature is below the ODS setpoint.*

4.4 Electric Heat / Outdoor Sensor / SCKT / EHDD (Heat Pumps) – Electric Heat (HP systems with electric heat)– When there is a request for “Electric Heat” (W2-signal via Digital input or Modbus), the system will run the Indoor Motor for 10 seconds prior to energizing the Heater Output. The Indoor Motor will operate at the “W2” speed setting on the board or via Modbus. Once the Heater output is energized, the Heater comes on at full capacity (no staging). The Heater will remain on until the Heating setpoint is satisfied and the request is dropped. Once the heating setpoint is satisfied, the Indoor motor continues to run based on the fan purge timer setpoint (default 90 seconds) selected in setting 3 of the configuration menu of the control board.

When the system is operating in Heat Pump mode the electric heat is considered as supplemental heat and will only be allowed under certain conditions due to additional features that may be used. These features include the Outdoor Sensor and SCKT (safety circuit). See ODS and SCKT for more details.

ODS - Outdoor Sensor (Heat-Pumps Only)

The outdoor sensor only responds to the temperature of the outside air. The sensor is a 10K NTC sensor probe. The factory setting is 50°F. This setpoint can be adjusted in 1F increments from 0F to 70F in the control board configuration menu setting 11.

If the optional Outdoor Sensor is used (Heat-pump systems only). The electric heat will not operate upon a request for “W2” unless the outdoor temperature is below the setpoint for the ODS setpoint. If the sensor is not connected or faulty the electric heat will be allowed to operate anytime a request for W2 is present.

Note: A request for Cooling and Electric Heat at the same time is not allowed and the control board will not allow the electric heat to operate.

SCKT – Safety Circuit (Heat-Pumps Only)

The SCKT is a selectable menu option in the control board configuration menu setting 10. The options for this feature are Y=Yes or N=No. When set to Y=Yes, control board will prevent the compressor and electric heat from operating simultaneously. In this case the compressor will shut off upon a request for “W2” (Electric Heat). The compressor will remain off as long as the request for W2 is active. Once the request for W2 satisfies the compressor will be allowed to operate. The default setting for SCKT is N=No, the electric heat and compressor will be allowed simultaneous operation in the heat pump heating mode.

Note: If the ODS is used the electric heat will not operate unless the outdoor temperature is below the ODS setpoint.

EHDD – Electric Heat During Defrost (Heat-Pumps Only)

The EHDD is a selectable menu option in the control board configuration menu setting 9. The options for this feature are Y=Yes or N=No. When set to Y=Yes, control board will force the electric heat to operate during a defrost cycle unless SCKT is set to Y=Yes or the outdoor temperature is not below ODS (if equipped) setpoint. The default setting for EHDD is Y=Yes.

Note: SCKT takes priority over ODS and EHDD.

5.0 Dehumidification Operation AC / HP

5.1 Hot Gas Reheat (if equipped) – When there is a request for “Dehumidification” (HUM-signal via Digital input or Modbus), this will result in the control board energizing the Indoor Fan (IBR), Compressor 1 (CC1), Compressor 2 (CC2), Reversing Valve (RV) “heat pumps only” and the Reheat (RH) relay outputs on the board. This forces the system to operate in the full capacity cooling mode while energizing the reheat solenoid valve to allow hot gas to be introduced into the supply air stream of the system for dehumidification operation. The indoor fan motor will operate at the “Dehum” speed setting on the board or via Modbus. The indoor fan remains on continuously but the outdoor fan modulates based on liquid line temperature. The Fan Cycle Control Sensor (Low Ambient Control Sensor) monitors the liquid line to maintain a 90F liquid line temperature. When the liquid line temperature is below 80F the outdoor fan will shut off. A liquid line temperature above 115F will force the outdoor fan to operate at the maximum speed set on the control board for setting 7 in the configuration menu. The outdoor fan will speed up and slow down between liquid line temperature of 80F and 115F. Systems with (PSC Outdoor Motors) utilizes a Fan Cycle Switch which closes at 400 PSIG to energize the OFR (outdoor fan relay) to start the outdoor fan which runs until the switch reopens (at 290 PSIG). These outputs

function as described until the Dehumidification setpoint is satisfied. This is considered as ON/OFF fan cycle control and the PSC motor will not modulate.

Note: A request for Y1 or Y2 via digital input or Modbus takes priority over dehumidification operation and the hot gas reheat valve will de-energize.

5.2 Electric Reheat (if equipped) – When there is a request for “Dehumidification” (HUM-signal via Digital input or Modbus), this will result in the control board energizing the Indoor Fan (IBR), Compressor 1 (CC1), Compressor 2 (CC2), Reversing Valve (RV) “heat pumps only” and the Reheat (RH) relay outputs on the board. This forces the system to operate in the full capacity cooling mode while energizing the electric heat to allow heat to be introduced into the supply air stream of the system for dehumidification operation. The indoor fan motor will operate at the “Dehum” speed setting on the board or via Modbus. The indoor fan remains on continuously but the outdoor fan modulates based on liquid line temperature. The Fan Cycle Control Sensor (Low Ambient Control Sensor) monitors the liquid line to maintain a 90F liquid line temperature. When the liquid line temperature is below 80F the outdoor fan will shut off. A liquid line temperature above 115F will force the outdoor fan to operate at the maximum speed set on the control board for setting 7 in the configuration menu. The outdoor fan will speed up and slow down between liquid line temperature of 80F and 115F. Systems with (PSC Outdoor Motors) utilizes a Fan Cycle Switch which closes at 400 PSIG to energize the OFR (outdoor fan relay) to start the outdoor fan which runs until the switch reopens (at 290 PSIG). These outputs function as described until the Dehumidification setpoint is satisfied. This is considered as ON/OFF fan cycle control and the PSC motor will not modulate.

Note: A request for Y1 or Y2 via digital input or Modbus takes priority over dehumidification operation and the electric heat will de-energize.

5.3 Pulse Reheat / Dehum Supply Set – The Pulse reheat feature allows for supply air temperature limiting dehumidification control. When setting 18 is set to Y in the configuration menu the RH output of the control board will energize and de-energized based on the dehumidification supply air temperature setpoint in setting 19 of the configuration menu. During dehumidification operation the RH output is energized and the supply air is monitored to allow the supply air to reach the dehumidification supply air setpoint. When the setpoint is reached, the RH output is de-energized and the system will operate in cooling mode until the supply air temperature drops 5°F. When the 5°F differential has been met the RH output will energize and dehumidification operation will resume. When setting 18 is set to N= No, Pulse Reheat is not active and the supply air will not be monitored to limit supply air temperature in the dehumidification mode. The Pulse Reheat and Dehum Supply Set may also be selected and adjusted via MODBUS.

6.0 Refrigeration Protection

6.1 High Pressure Lockout – This condition describes the abnormal rise in Head Pressure within system with an acceptable limit of 660 PSI (+/-20PSI). The fault will only be active when the High-Pressure Switch (Normally Closed) opens during a request for Cooling or Heat Pump Heating. The first time this fault condition occurs, the system cuts the compressor off WITHOUT locking out. Once the pressure normalizes (drops below 450 PSI), the system will resume operation if the cooling or heat pump heating call still exist. If this fault occurs a second time on the same Cooling or Heat pump heating request, the system locks out. Lockouts can be monitored using the control board display for the current fault. The fault for a high-pressure lockout will displayed as “HP-1” or “HP-2” followed by “F”. The faults can also be monitored via Modbus by reading the respective value based on the Modbus map that is provided. After this lockout condition is reached, the cooling/heat pump heating call must be cycled (on/off of respective request) or the system must be power cycled to clear the fault. For a 2-compressor

system, each lockout is isolated to the respective circuit and will not interfere with the operation of the other circuit providing that the circuits operate independently. The system will continue to lockout until the problem is rectified.

- 6.2 Low Pressure Lockout / Freeze Protection** – A10K Nominal NTC Thermistor is connected to the “LPS 1” and “LPS2” inputs of the control board for circuit 1 and circuit 2 respectively. The sensor is secured to the common suction line of the system to monitor the suction line temperature.

This condition describes the abnormal fall in Suction Line Temperature below 9°F. This fault will only be active when the Low-Pressure Sensor detects suction line temperatures below 9°F during a request for Cooling / Heat pump heating. The Low-Pressure Sensor is bypassed on the initial call for cooling for 3 minutes to allow low ambient start-up of the system. Once these 3 minutes have elapsed plus a 2-minute validation timer (5 minutes total), if the sensor remains below 9°F, the system cuts the compressor off. The system will remain off for the defaulted 3-minute anti-short cycle time and then the system will restart the cooling / heat pump heating operation and the 3-minute bypass timer begins. Once these 3 minutes have elapsed plus a 2-minute validation timer (5 minutes total), if the sensor remains below 9°F the system locks out. Lockouts can be monitored using the control board display for the current fault. The fault for a low-pressure lockout will displayed as “LP-1” or “LP-2” followed by “F”. The faults can also be monitored via Modbus by reading the respective value based on the Modbus map that is provided. After this lockout condition is reached, the cooling/heat pump heating call must be cycled (on/off of respective request) or the system must be power cycled to clear the fault. For a 2-compressor system, each lockout is isolated to the respective circuit and will not interfere with the operation of the other circuit providing that the circuits operate independently. The system will continue to lockout until the problem is rectified.

- 6.3 Anti-Short Cycle** – This is a built-in protection mechanism that increases the reliability of the compressor by protecting it from excessive short cycling. When the compressor goes off, due to any fault, emergency or if the cooling / heat pump heating setpoint is satisfied, a built-in 3-minute timer locks the compressor for that respective circuit out. This can be monitored by referencing the appropriate MODBUS read only variable. However, it can only be monitored at the board level by waiting for the 3 minutes to elapse.

- 6.4 Loss of Charge / Flat Unit Fault** – The LPS 1 and FCC 1 sensors are monitored during compressor operation to determine a temperature differential of at least 10F between the two sensors. After a 3 minutes bypass timer has expired the LPS 1 and FCC 1 are monitored for differential temperature. If the differential temperature is 10F of less between the two sensors, the compressor will enter a hard lockout and an “Lc” fault will be displayed on the screen of the control board. The faults can also be monitored via MODBUS by reading the respective value based on the MODBUS map that is provided. After this lockout condition is reached, the system must be power cycled to clear the fault.

Note: The LPS 1 and FCC 1 sensors are both required to be connected to the control board to monitor for this fault. If a sensor is disconnected, the board will display the “Lc” until the both sensors are connected and in working condition.

7.0 Additional Features

- 7.1 Modulating Head Pressure Control (ECM Outdoor Motors)**– A10K Nominal NTC Thermistor is connected to the “FCC1” and “FCC2” inputs for circuit 1 and circuit 2 respectively. The sensor is secured to the liquid line of the system to monitor the liquid line temperature. When this sensor is connected, the thermistor value is used as the process variable when controlling the head pressure. The controller modulates the Outdoor Fan Motor to maintain a 90°F temperature

setpoint. The controller will always use the greater value of FCC1 and FCC2 input as the reference point. In the event that the Thermistor is disconnected, the controller reverts to the outdoor fan operating at the max speed setting selected on the control board configuration menu setting 7.

Note: Systems with PSC outdoor motors utilize a fan cycle switch in the refrigeration circuit for on/off fan cycle head pressure control.

PSC Motor Head Pressure Control

The onboard outdoor fan relay (OFR) is used to control the Fan Cycle Switch based on CC output to the Compressor. Once the compressor out (CC1) is energized the OFR output will also be energized and the fan cycle switch will cycle on and off at 290psi and 400psi. This will turn the Outdoor Fan Motor on and off to maintain the head-pressure of the system, the OFR output is only used on systems with PSC out door motor and Fan Cycle Switch (FCC) only.

7.2 Emergency Ventilation (Motorized Damper or Economizer Equipped Systems)– When there is a request for “Emergency Ventilation” (EV-signal via Digital input or Modbus), the system will run the Indoor Motor at the “Y2” speed setting on the board or via Modbus and provide a 10vdc signal from the ECO output of the control board to drive the motorized damper fully open.

Note: The compressor and electric heat WILL NOT operate while in the emergency ventilation mode.

7.3 Forced Cooling (economizer equipped systems) – During economizer cooling, if a request for “Forced Cooling” (FC-signal via Digital input or Modbus) is present. The control board will force the economizer to close and start the compressor to operate at full capacity cooling. This is considered an override of the economizer in the event economizer cooling can’t keep up with the cooling demand in economizer mode. The Indoor Motor at the “Y2” speed setting on the board or via Modbus and the system will operate in normal cooling mode until the request for FC is satisfied. Once satisfied the system will be allowed to return to economizer operation if conditions are favorable.

7.4 Low Voltage (Brownout)– The control board monitors the 24 VAC power supply for low voltage protection. When the power supply voltage is 16 VAC or less for 10 seconds the control board will de-energize all outputs. This is considered a voltage brownout (low voltage) condition and the display of the control board will show “03” as an indicator of brownout (low voltage). When the voltage rises back to 17 VAC, the control board will allow the system to operate.

Note: The nominal power supply for the control board is 24VAC and this voltage should be confirmed during startup to assure normal operation.

8.0 Smoke / Fire Shutdown

8.1 System Shutdown Contact Wiring– Add Normally Closed Dry contacts as shown for immediate shutdown of HVAC upon contacts opening.

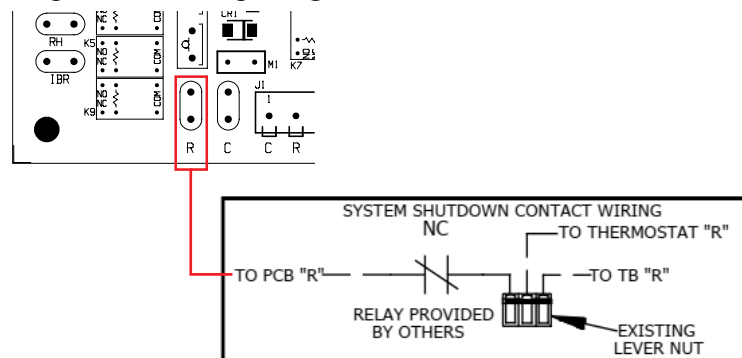

Chapter 3 Installation



WARNING

Failure to observe and follow Warnings and Cautions and these Instructions could result in death, bodily injury or property damage. Read this manual and follow its instructions and adhere to all Cautions and Warnings in the manual and on the Marvair unit.

3.1 Equipment Inspection

Concealed Damage

Inspect all cartons and packages upon receipt for damage in transit. Remove cartons and check for concealed damage. Important: Keep the unit upright at all times. Remove access panels and examine component parts. (Note: The bottom bracket is stored in the condenser air compartment. Remove them before replacing the side screen). Inspect refrigerant circuit for fractures or breaks. The presence of refrigerant oil usually indicates a rupture. If damage is apparent, immediately file a claim with the freight carrier.

Units that have been turned on their sides or tops may have concealed damage to compressor motor mounts, to the oil system or to other components. If the unit is not upright, immediately file a claim for concealed damages and follow these steps:

1. Set unit upright and allow to stand for 24 hours with primary power turned on.
2. Attempt to start the compressor after 24 hours.
3. If the compressor will not start, makes excessive noise, or will not operate, return the unit to the freight carrier.

General

1. Inspect unit for completeness. Check for missing parts (e.g. hardware). Refer to the installation kit information in section 2.3.
2. Remove access panels and check for loose wires. Tighten screw connections.
3. Complete and mail the warranty registration card.

3.2 Installation Requirements

You must consider all of the following when choosing the installation site:

1. **Noise.** Install the unit so that the least amount of noise will be transmitted to inhabited spaces.
2. **Condensate Drainage.** Condensate produced during operation must be discharged to a suitable drain.
3. **Defrost Drainage.** Ice build up sometime occurs during the heating cycle while in heat pump operation. The automatic reversal (defrost control) of the heat pump cycle causes the ice to melt so that the heat pump may operate efficiently. Please keep this in mind while locating unit.
4. **Placement.**
 - A) Place the unit in a shaded area, if possible.
 - B) Install it above ground for protection against flooding.
 - C) The unit exhausts air. Be sure that the airflow is not impeded by shrubbery or other obstructions.
 - D) When installing multiple units, please note the recommended clearances noted in Table 4.

5. **Airflow Requirements:**

Note the minimum CFM requirements (section 2.4). Keep duct lengths as short as possible. Do not obstruct airflow through the unit.

Applications using duct work should be designed and installed in accordance with all applicable safety codes and standards. Marvair® strongly recommends referring to the current edition of the National Fire Protection Association Standards 90A and 90B before designing and installing duct work. The duct system must be engineered to insure sufficient air flow through the unit to prevent over-heating of the heater element. This includes proper supply duct sizing, sufficient quantity of supply registers, and adequate return and filter areas. Duct work must be of correct material and must be properly insulated. Duct work must be constructed of galvanized steel with a minimum thickness of .019". Duct work must be firmly attached, secured, and sealed to prevent air leakage. See section 2.4 for additional duct work requirements.

6. **Clearances:**

When facing the unit from the outside, the minimum clearances are found below. Note the minimum clearances required for proper operation and service (Tables 4a & 4b below).

MODEL	Min. Clearance From the Front	Min. Clearance Around Sides (Single Unit)	Min. Clearance Between Sides (Two Units)	Min. Space Above Unit
MAA1020H/1024H & MAA2024H	120 inches	30 inches	18 inches	24 inches
MAA1030H/1036H & MAA2030H/2036H	120 inches	30 inches	18 inches	24 inches
MAA1042H/1048H & MAA2042H/2048H	120 inches	30 inches	30 inches	24 inches
MAA1060H & MAA2060H	120 inches	30 inches	30 inches	24 inches

Table 6 - Minimum Clearances

7. **Codes:**

Make sure your installation conforms to all applicable electrical, plumbing, building, and municipal codes. Some codes may limit installation to single story structures.

8. **Electrical Supply:**

The power supply must have the appropriate voltage, phase, and ampacity for the model selected. Voltage must be maintained above minimum specified values listed below. Refer to the unit data plate for ampacity requirements.

Electrical Rating Designations*	A	C	D
Nominal Voltage	208/230	208/230	460
Phase	1	3	3
Minimum Voltage	197	197	414
Maximum Voltage	253	253	506
* Letters refer to model number code designations. Refer to page 5.			

Table 7 - Voltage Limitations

3.3 Installation Materials

Installation Kits

Marvair MAA Heat Pumps have built-in mounting flanges that function as side brackets. All models require and are shipped with a bottom mounting bracket. On units with the "N" ventilation option, there is a fresh air hood factory installed behind the lower front panel.

Standard Kit Components

1. One 12 Ga. “L”-shaped bottom bracket

Accessories:

The package may include other factory-supplied items (optional) listed on this and the following page:

PART # DESCRIPTION

- 50107 Digital thermostat. 2 stage heat, 2 stage cool. 7 day programmable. Fan switch: Auto & On. Auto-change over. Status LED’s. Backlit display. Programmable fan. Non-volatile program memory. Title 24 compliant - no batteries needed.
- 50252 Digital thermostat. 2 stage heat, 2 stage cool. Non-programmable. Fan switch: Auto & On. Manual or auto changeover system switch: Cool-Off-Heat-Emergency Heat. Status LED’s. °F or °C. Permanent retention of settings on power loss. Field adjustable temperature calibration. Adjustable maximum setpoint for heating and minimum adjustable set points for cooling. Adjustable temperature differential. Keypad lockout.
- 50248 Digital, 7 day, 2 occupied & 2 unoccupied periods for each day of the week programmable thermostat. Three stage heat/Three stage cool. Manual or auto changeover. Fan: Auto & On. Ten year retention of programming settings and 48 hour clock and day settings on power loss. Adjustable max. setpoint for heating and min. adjustable setpoints for cooling. Adjustable temperature differential. Keypad lockout. Status LED. °F or °C selectable. Optional remote sensors for outdoor air, supply air and humidity. Title 24 compliant.
- 50254 Humidity Controller is a wall mounted remote control used when the reheat dehumidification option is chosen on the Heat Pump. The humidity controller controls the heat pump system when cooling or heating requirements are satisfied, and the need exists to dehumidify the conditioned space. When cooling or heating is required the thermostat controls the heat pump system operation.
- 50092 Thermostat Guard. For use with the 50107 and the 50252.

Grilles:

Description	Size	Marvair P/N
<i>For the MAA1020H/1024H & MAA2024H</i>		
Double Deflection, Aluminum Supply Grille	20" x 8" (509mm x 203mm)	80674
Aluminum Return Grille	20" x 12" (509mm x 305mm)	80677
Return Filter Grille	20" x 12" (509mm x 305mm)	80671
<i>For the MAA1030H/1036H & MAA2030H/2036H</i>		
Double Deflection, Aluminum Supply Grille	28" x 8" (711mm x 203mm)	80675
Aluminum Return Grille	28" x 14" (711mm x 356mm)	80678
Return Filter Grille*	28" x 14" (711mm x 356mm)	80672
<i>For the MAA1042H/1048H/1060H & MAA2042H/2048H/2060H</i>		
Double Deflection, Aluminum Supply Grille	30" x 10" (762mm x 254mm)	80676
Aluminum Return Grille	30" x 16" (762mm x 406mm)	80679
Return Filter Grille	30" x 16" (762mm x 406mm)	80673
Note: Return filter grilles should be used when the 2" (51mm) filter in the MAA unit is not accessible from the exterior of the building. Filter used in the return filter grille is a 1" (25mm) thick filter. The return filter grille is not recommended for use with the MAA heat pumps with economizers.		

Additional Items Needed:

Additional hardware and miscellaneous supplies (not furnished by Marvair®) are needed for installation. For example, the list below contains approximate quantities of items typically needed for mounting a unit on a wood frame wall structure with standard full length mounting bracket or flanges. Concrete or fiberglass structures have different requirements.

- (10) **3/8" mounting bolts** or lag screws for side brackets and anchors, if required for side brackets.
- (20) **3/8" washers**
- (10) **3/8" hex nuts**
- (6) **3/8" x 2-1/2" lag screws** for bottom bracket
 - **Silicone Sealer** to seal around cracks and openings
 - **7-conductor low voltage multi-colored wire cable** (i.e. thermostat wire)
 - **Appropriate electrical supplies** such as **conduit, electrical boxes, fittings, wire connectors,** etc.
 - **High voltage wire**, sized to handle the MCA (minimum circuit ampacity) listed on the data plate.
 - **Over-Current Protection Device** sized in accordance with the MFS (maximum fuse size) listed on the unit data plate.

Duct materials usually are also needed in addition to the mounting hardware. To save time, design the duct work before mounting the unit.

3.4 Porting and Duct Work

 **WARNING**
FIRE HAZARD

Improper adjustment, alteration, service, maintenance or installation could cause serious injury, death and/or property damage.

Installation or repairs made by unqualified persons could result in hazards to you and others. Installation MUST conform with local codes or, in the absence of local codes, with codes of all governmental authorities have jurisdiction.

The information contained in this manual is intended for use by a qualified service agency that is experienced in such work, is familiar with all precautions and safety procedures required in such work, and is equipped with the proper tools and test instruments.

General Information

Note: The following instructions are for general guidance only. Due to the wide variety of installation possibilities, specific instructions will not be given. When in doubt, follow standard and accepted installation practices, or contact Marvair® for additional assistance.

Wall Openings

Measure the dimensions of the supply and return openings on the heat pump unit.

 **WARNING**

Cut the supply opening in the exterior wall for the supply and return. IMPORTANT: All units must have one inch clearance on all four sides of the supply outlet duct flange on the unit. The one inch clearance must extend on all sides of the supply duct for the first three feet from the unit. The duct must be constructed of galvanized steel with a minimum thickness of .019".

Minimum Airflow Requirements

 **WARNING**

The duct system must be engineered to assure sufficient air flow through the Heat Pump, even under adverse conditions such as dirty filters, etc. Proper engineering will insure longevity and maximum performance from the Heat Pump unit.

Ducting

Extensions should be cut flush with the inside wall for applications without duct work.

Applications using duct work should be designed and installed in accordance with all applicable safety codes and standards. Marvair® strongly recommends referring to the current edition of the National Fire Protection Association Standards 90A and 90B before designing and installing duct work. The duct system must be engineered to insure sufficient air flow through the unit to prevent over-heating of the heater element. This includes proper supply duct sizing, sufficient quantity of supply registers, adequate return and filter area. Ductwork must be of correct material and must be properly insulated. Ductwork must be constructed of galvanized steel with a minimum thickness of .019". Ductwork must be firmly attached, secured and sealed to prevent air leakage. Do not use duct liner on inside of supply duct within four feet of the unit.

Galvanized metal duct extensions should be used to simplify connections to duct work and grilles. Use fabric boots to prevent the transmission of vibration through the duct system. The fabric must be U.L. rated (UL-181) to a minimum of 197°F.

3.5 Fresh Air Hood

The fresh air hood is located on the inside, behind the slots on the bottom front panel. To access the hood, remove the screws that hold the front panel. The air flow can be adjusted from no (0%) fresh air to approximately 15% of rated air flow of fresh air, in 5% increments. The hood is shipped from the factory in the closed position (no fresh air). To provide fresh air, remove the two screws on either side of the hood and reposition as desired.

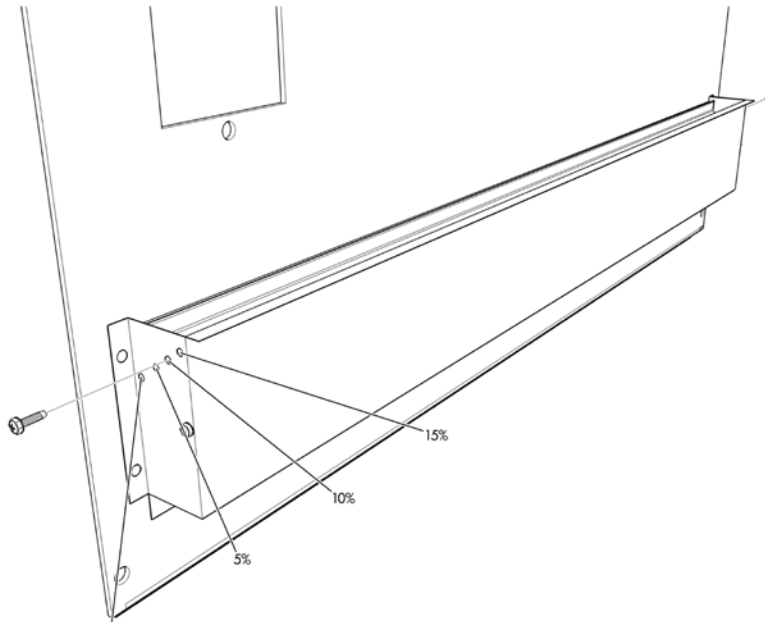
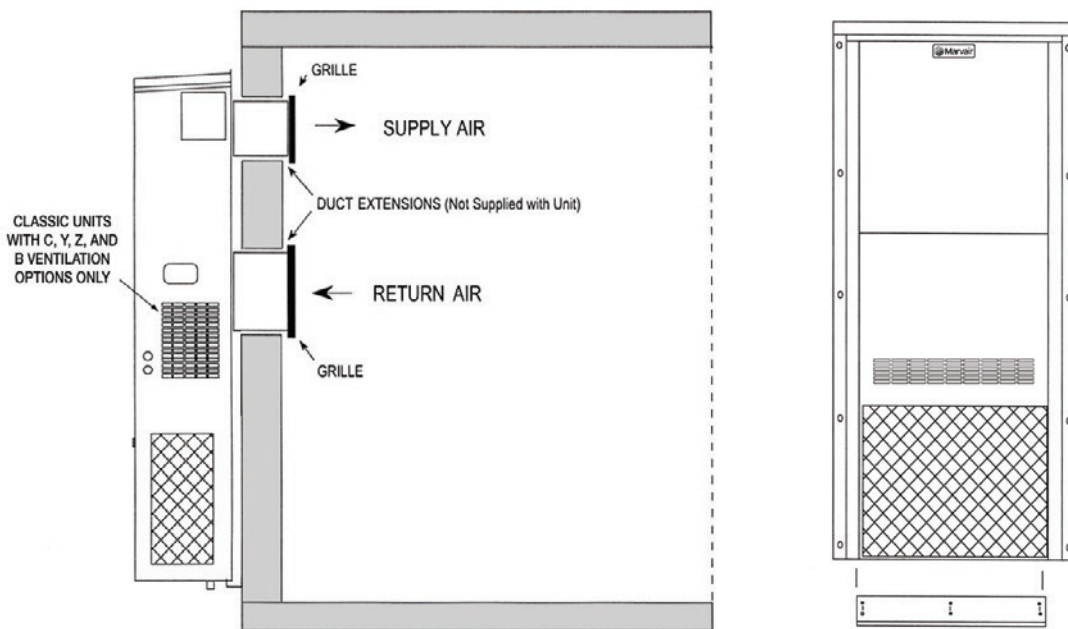

Figure 4 - Fresh Air Hood Damper Adjustment

3.6 Bottom Bracket Installation

1. Remove and discard the 4 x 4 shipping boards attached to the base of the unit.
2. All heat pump models have built-in mounting flanges. See Figure 6.
3. Refer to Figure 6. Attach the bottom support bracket to the wall using appropriate 3/8" diameter hardware.

For example, on wooden structures, use 3/8 x 2-1/2 inch all-thread lag screws. The screws must penetrate the center of the wall stud. Drill a pilot hole in the stud to prevent it from splitting.



For units with electric heat, a 1" clearance around the duct extensions is required. The duct extensions must be made of galvanized steel with a minimum thickness of .019" as per the NFPA standards 90A & 90B.

Figure 5 - Heat Pump Wall Mounting Detail

3.7 Mounting the Unit

1. For wiring into the back of unit, locate the lower of the two knock-outs on the wall side of the Heat Pump. Drill a one inch hole in the building wall to match this opening. Allow sufficient clearance to run 3/4" conduit through the hole and to the unit.
2. Apply a bead of silicone sealer on the wall side of the mounting brackets on the Heat Pump. Circle the mounting holes with the silicone bead.
3. **Using an appropriate and safe lifting device**, set the Heat Pump on the bottom support bracket mounted on the wall. You must stabilize the unit on the bracket with the lifting device or by some other means - the bracket alone is not sufficient.
4. Make sure that the duct flanges are properly aligned with the wall opening. Adjust as necessary.
5. Note the holes in each side bracket. Using the holes for guides, drill holes through the wall with a 3/8 inch drill bit. Insert the 3/8" bolts or lag screws through the brackets. Tighten the bolts to secure the unit.
6. Apply a bead of silicone where the top flange and side brackets contact to the structure wall.
7. Fasten the top flange to the wall using #10 x 1/2 inch sheet metal screws.
8. On the inside of the structure, wall sleeves must be installed in the supply and return air openings. The sleeves should be trimmed to fit flush with the inside wall. For units with electric heat, a one inch clearance is required around the duct extensions. The duct extensions must be constructed of galvanized steel with a minimum thickness of .019" as per the NFPA standards 90A & 90B.
9. Check the fit of each sleeve to its mating flange for possible air leaks. Apply silicone sealer to close any gaps. Install the air return and supply grilles.
10. To minimize sound transmission, a latex based, insulating foam seal may be applied between the duct extensions and the frame for the wall openings. **NOTE: DO NOT USE THE FOAM ON ANY UNITS WITH ELECTRIC RESISTANT HEATERS.**

3.8 Electrical Connections

WARNING - ELECTRICAL SHOCK HAZARD

Failure to follow safety warnings exactly could result in serious injury, death, and/or property damage.

Turn off electrical power at fuse box or service panel **BEFORE** making any electrical connections and ensure a proper ground connection is made before connecting line voltage.

All electrical work must meet the requirements of local codes and ordinances. Work should be done only by qualified persons.

CAUTION

This Marvair Heat Pump may incorporate an internal crankcase heater for compressor protection. **The crankcase heater must be energized for at least 24 hours prior to starting the compressor.**

High Voltage Wiring

The power supply should have the proper voltage, phase, and ampacity for the selected model.

1. Refer to the electrical data on the data sticker on the unit for field wiring requirements of the unit. Size the incoming power supply lines and the fuse(s) or HACR breaker(s) according to requirements described in the National Electric Code. Run the power conductors through the knockouts on the side or back of the unit. Use appropriate conduit and strain reliefs.

CAUTION

Note: Power supply service must be within allowable range (+10% - 5%) of rated voltage stamped on the unit rating plate. To operate nominal 230/208V unit at 208V, change the transformer line tap from 240V to 208V following the instruction on wiring label in unit.

2. Connect the wires to the input side of the internal breaker (L1 & L2 for single-phase units; L1, L2, & L3 for three phase models).

CAUTION

CAUTION! This system contains components that require phasing for correct rotation. Failure to observe rotation and correct on start-up will cause damage not covered by the Marvair® Warranty.

3. Scroll compressors, like several other types of compressors, will only compress in one rotational direction. The direction of rotation is not an issue with single-phase compressors since they will always start and run in the proper direction. However, three phase compressors will rotate in either direction depending upon phasing of power. Since there is a 50-50 chance of connecting power in such a way as to cause rotation in the reverse direction, it is imperative to confirm that the compressor is rotating in the proper direction at the initial field start-up of the system. Verification of proper rotation is made by observing that the suction pressure drops and the discharge pressure rises when the compressor is energized. An alternate method of verification for self contained system with small critical refrigerant charges, where the installation of gauges may be objectionable, can be made by

monitoring the temperature of the refrigerant lines at the compressor. The temperature should rise on the discharge line while the suction line temperature decreases. Reverse rotation also results in a substantially reduced current draw when compared to tabulated values.

There is no negative impact on durability caused by operating three phase compressors in the reversed direction for a short duration of time, usually defined as less than one hour. However, after several minutes of operation the compressor's internal protector will trip. The compressor will then cycle on the protector until the phasing is corrected. Reverse operation for longer than one hour may have a negative impact on the bearings.

To change the rotation, turn off power to the unit and reverse L1 & L2 at the disconnect.

4. Install the ground wire on the ground lug.
5. Units designed to operate on 460v. have a step down transformer for 230v. motors.

Low Voltage Wiring

1. Pull the low voltage wiring from the Heat Pump to the thermostat / sub-base assembly. Use 18 gauge, with at least 7-conductors, Class 2 thermostat wire.
2. Mount the sub-base on a level plane. Connect the thermostat wire to the unit terminal board and the thermostat as shown in Figure 7.
3. If applicable, attach the thermostat assembly to the sub-base. Check the stage two heat anticipator setting. For units with electric heat and thermostats with an adjustable heat anticipator, energize the electric heat and measure the current on the lead attached to the W2 terminal. Adjust/set the heat anticipator per the instructions provided with the thermostat.

Terminals 8 & 10 on the Marvair with economizer can be connected to a normally closed smoke alarm or fire stat to cause equipment shutdown when the circuit is opened. (Remove factory jumper).

⚠ CAUTION

The internal transformer is not designed to power other external devices.

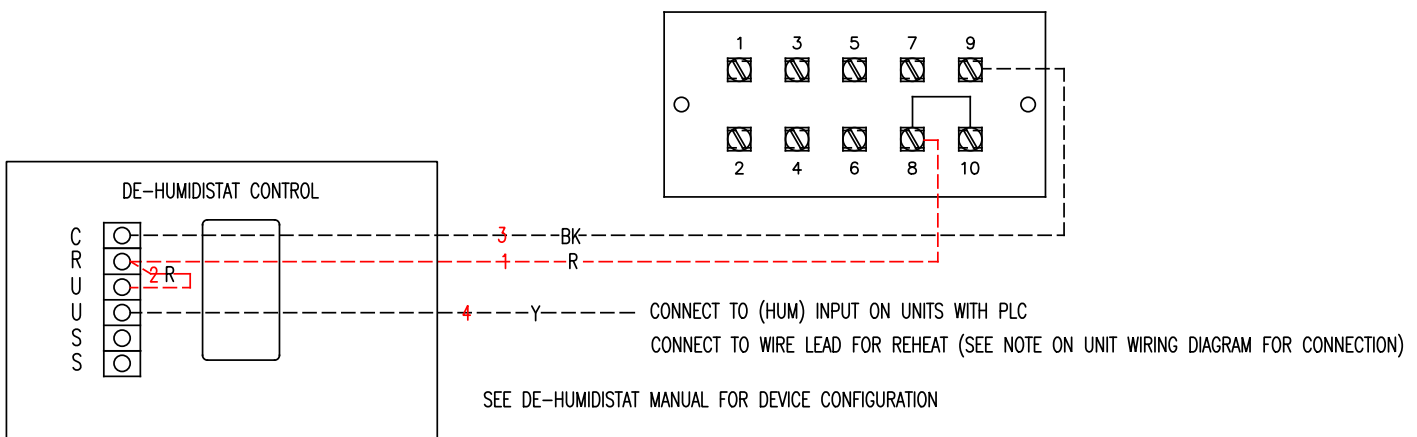
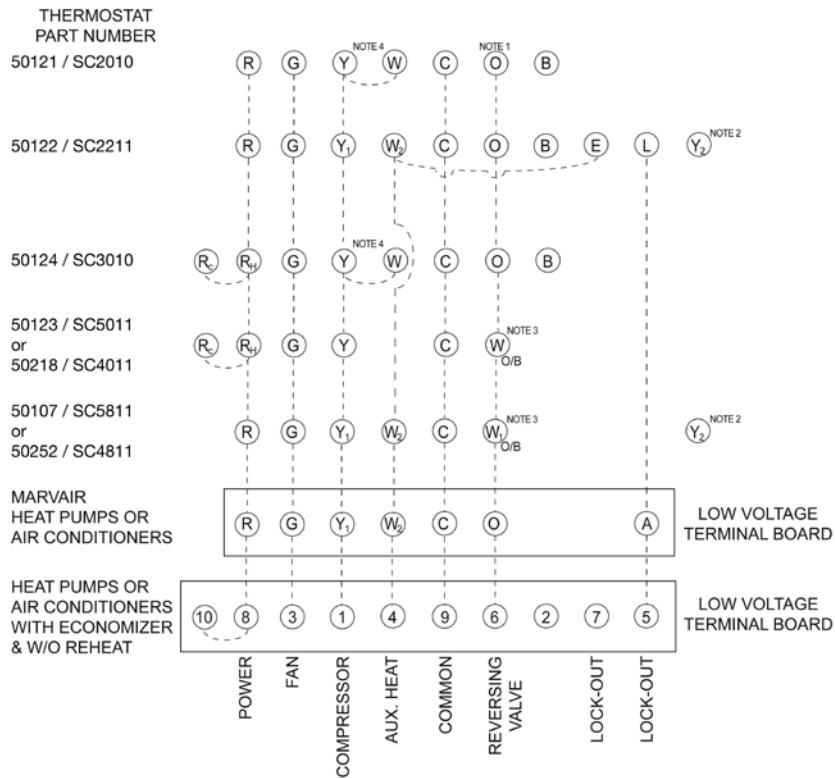

Figure 6a - Humidity Control Wiring Detail - Heat Pumps



NOTES:

1. Reversing valve on heat pumps only.
2. For units with 2-stage compressors, connect lead from the compressor monitor and diagnostic module, e.g., Copeland's Comfort Alert, to Y₂.
3. For air conditioners with strip heat, connect W/O/B to terminal W or 4.
4. Jumper for heat pump only, omit with air conditioners.
- A. Terminals 5 & 7 are normally open dry contacts and close to indicate lockout.
- B. Terminals 6 & 7 are normally closed dry contacts and open to indicate lockout.
- C. If the thermostat has RC & RH terminals, install a jumper wire between RC & RH.
- D. IMPORTANT. The instructions are generic wiring instructions and may not be applicable for air conditioners with various options. Always refer to the wiring diagram in the air conditioner for the proper method to wire your unit.

Figure 6b - Thermostat Connection Diagram

Chapter 4 Startup

IMPORTANT

If the heat pump unit has a crankcase heater be sure that the crankcase heater has been energized for at least 24 hours prior to start-up of the unit. Double check all electrical connections before applying power. Various thermostats can be used to control the heat pump. The thermostat may have a fan switch with an Automatic and On positions, a system switch with Heat, Cool, and Off positions, and an emergency heat position with lights. The spec sheets have detailed description of the various Marvair® thermostats. Since other thermostats or remote control systems may be used, the following procedures should be viewed as guidelines for standard thermostats with system and fan switches.

4.1 Check-out of Cooling Cycle

Procedure:

1. Set the fan switch to "Auto" and the system switch to "Off".
2. Move the cooling set point temperature on the wall thermostat to a point higher than the room temperature. Move the heating set point temperature to a temperature that is lower than the room temperature.
3. Set the thermostats system switch to "Cool" or "Auto" position. Nothing should operate at this time.
4. Set the time delay in the control box to three minutes. Note that time delay is an option on some Marvair units and may not be on your heat pump.
5. Remove the cover plate from the thermostat. Slowly lower the thermostat cooling set point temperature. Once the indoor fan turns on, allow approximately three minutes for the compressor and outdoor fan to start.

For units equipped with the low ambient control, note that the outdoor fan may not come on immediately, because it is cycled by refrigerant pressures. Some units have a time delay module which prevents the compressor from restarting immediately after interruption of power. See section 1.5 for details on the operation of the low ambient control and the time delay.

If the unit fails to operate, refer to the troubleshooting information in Chapter 4.

Heat Pump unit with Economizer

1. Set the fan switch to "Auto" and the system switch to "Off".
2. Set the cooling set point temperature on the wall thermostat to a point higher than the room temperature. Set the heating set point temperature to a temperature that is lower than room temperature.
3. Set the thermostat system switch in the "Auto" or "Cool" position. Nothing should operate at this time.
4. Set the time delay in the **Heat Pump with Economizer** control box to 3 minutes. Check the enthalpy changeover setting of the H205A or dry bulb sensor, and reset it if needed. See section 1.7.
5. Slowly lower the thermostat's cooling set point temperature. The indoor fan should operate.

Once the indoor fan comes on, allow approximately three minutes for the compressor to start. Note that the outdoor fan may not come on immediately because it is cycled by refrigerant pressures

Note: To check the system operation under different ambient conditions, the air temperature and enthalpy sensors must be "tricked". When outdoor ambient conditions are higher than the control setting, a component aerosol cooler may be sprayed directly into the enthalpy sensor to simulate low enthalpy conditions, causing the economizer damper to open.

Alternately, when outdoor conditions are lower than the set point, a source of heat such as a hair dryer can be directed on the air temperature sensor to simulate warmer conditions, which will bring on mechanical cooling and start the compressor.

If the unit fails to operate, refer to the troubleshooting information in Chapter 4.

4.2 Check-Out of Heating Cycle

Procedure:

1. Place the thermostat system switch to "Auto" or "Heat" and the fan to "Auto".
2. Raise the heating set point temperature to a setting which is higher than the room temperature. The fan and compressor should cycle on after time delay (standard on Marvair heat pumps with an economizer and optional on all other Marvair units) has cycled.
3. Move the system switch to the "Off" position. All functions should stop.

The Blower Timed Delay Relay (BTR) keeps the blower running for 90 seconds after the unit shuts off.

Note: The damper blade should remain closed during the heating cycle (unless the minimum position potentiometer has been set for constant ventilation).

4.3 Discharge Air Temperature Adjustment of Modulating

Hot Gas Reheat (HGR) Valve

Units with Hot Gas Reheat may use a valve, a PC board and temperature sensor to maintain a constant discharge temperature during reheat operation. The discharge air temperature can be adjusted by the use of a potentiometer located on the PC board. The board is located in the control box of the unit. A Digital VOM is required to adjust the potentiometer.

WARNING - ELECTRICAL SHOCK HAZARD

The setting of the discharge air temperature requires that power be applied to the unit and the unit operating. Use extreme caution when working in the control box.

1. Make sure the two sensor wires are connected to the TEMP SENSOR terminals on the board. See Figure 7.

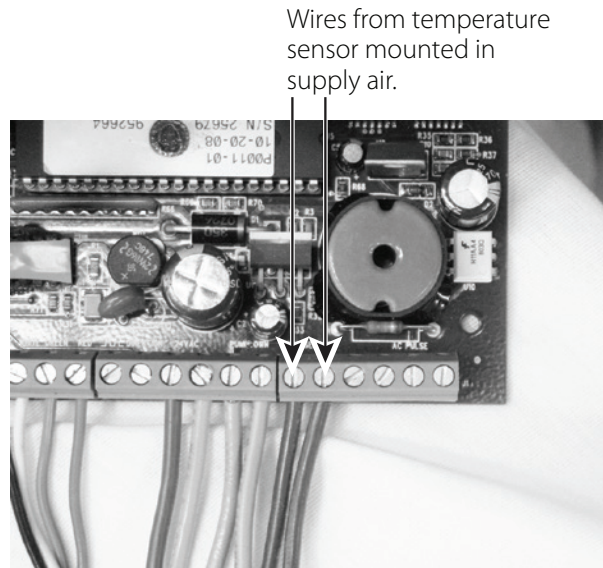

Figure 7 - Temperature Sensor Wires

2. Turn the unit on and the Hot Gas Reheat is operating.
3. Set the digital VOM for DC milliamp voltage. The milliamp voltage shown on the meter's display corresponds to the desired air temperature (°F). Insert the probes of the meter into the negative (black) and positive (red) set point test terminals on the board. Carefully, and in small increments, turn the blue knob on the potentiometer until the volt meter displays the desired milliamp voltage (temperature). Airxcel Commercial Group recommends 70°F and no lower than 68°F and no higher than 78°F. Allow the refrigerant system to stabilize for at least five minutes and adjust the temperature as desired.

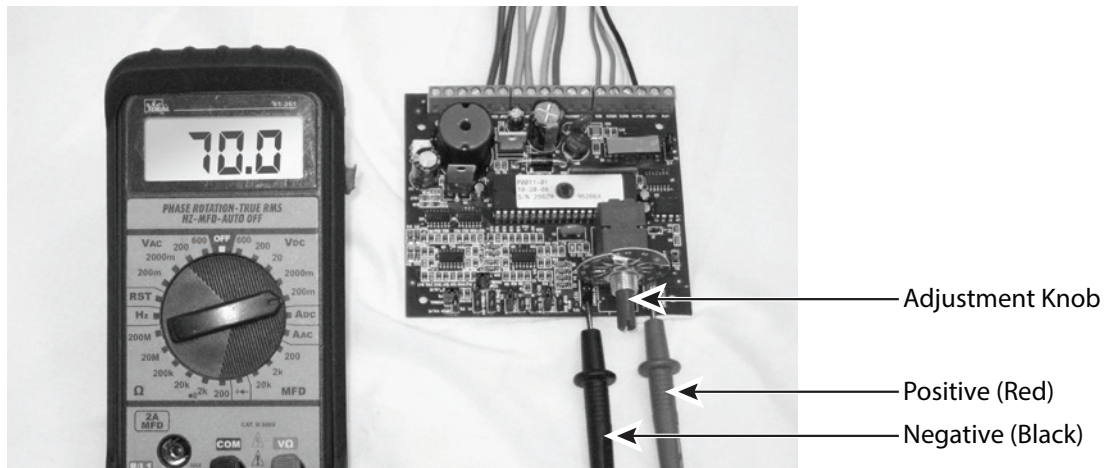

Figure 8 - Desired Temperature Set Point

4.4 Ventilation System Set-Up:

GreenWheel® ERV (Configuration H):

Setting the correct air flow for the GreenWheel ERV requires a balometer and a screwdriver.

- a. Using best industry standards and practices, measure the fresh air that is being brought into the classroom. For units with one speed controller (std.), adjust the speed of the intake and exhaust blowers by inserting a slotted screw driver into the opening on the controller. The speed controller is located on the lower right side of the GreenWheel ERV assembly. Access to the speed controller is through the return air grille. Measure the intake air again and adjust the speed of the blowers. Repeat as necessary to meet the fresh air requirements.
- b. For units with the optional variable fan speed controller for the GreenWheel® ERV exhaust blower, first measure the air being introduced into the classroom using best industry standards and practices. Adjust the speed of the intake air GreenWheel ERV blower until the required outside air is being brought into the classroom.
- c. Now measure the exhaust air from the classroom. Adjust the speed of the exhaust air GreenWheel ERV blower until the required air is being exhausted from the classroom. The exhaust air controller is located on the lower left side of the GreenWheel ERV assembly. Access to the exhaust air controller is through the return air grille. It is usual practice to pressurize the classroom by exhausting slightly less air than is being brought into the classroom.

Evaporator Variable Fan Speed Controller (Optional)

Indoor evaporator fan controller is accessed through the return air opening. The controller is located on the GreenWheel ERV assembly on the air separation box in a 2" x 4" "J" box.

Note: Sufficient airflow is required for proper operation of the unit.

Manual Fresh Air System (Configuration N):

This is the standard ventilation system in Marvair heat pumps. Fresh air ventilation by means of a damper can provide up to 15% of rated air flow of outside air. The damper has four positions corresponding to 0, 5, 10 and 15% of rated air flow of outside air.

The damper only opens when the indoor fan is operating. Position the screw on the side of the damper hood for the desired air flow.

Chapter 5 Troubleshooting

5.1 Overview

A comprehensive understanding of the operation of the Marvair® Heat Pump is a prerequisite to troubleshooting. Please read the Chapter 1 for basic information about the unit.

Marvair Heat Pumps are thoroughly tested before they are shipped from the factory. However, it is possible that a defect may escape undetected, or damage may have occurred during transportation. However, the great majority of problems result from installation errors.

If you experience difficulties with the Heat Pump, please review the installation steps in Chapter 2.

Much time can be saved by taking a thoughtful and orderly approach to troubleshooting. Start with a visual check - are there loose wires, crimped tubing, missing parts, etc? Begin deeper analysis only after making this initial inspection.

The troubleshooting information in this manual is basic. The troubleshooting section contains problem / solution charts for general problems, followed by a compressor section.

Not every problem can be anticipated. If you discover a problem that is not covered in this manual, we would be very grateful if you would bring it to the attention of our service department for incorporation in future revisions.

As always, please exercise caution and good judgement when servicing your Heat Pump. Use only safe and proven service techniques. Use refrigeration goggles when servicing the refrigeration circuit.

The refrigerant circuit has hot surfaces, and the electrical voltages inside of the unit may be hazardous or lethal. **SERVICE MAY BE PERFORMED ONLY BY QUALIFIED AND EXPERIENCED PERSONS.**

WARNING

The refrigerant circuit has hot surfaces, and the electrical voltages inside of the unit may be hazardous or lethal. SERVICE MAY BE PERFORMED ONLY BY QUALIFIED AND EXPERIENCED PERSONS.

5.2 Failure Symptoms Guide

PROBLEM/SYMP TOM	LIKELY CAUSE(S)	CORRECTION
<p>A. Unit does not run.</p> <p>NOTE: An internal anti-short-cycle timer will prevent the unit from starting for .2 to 8 minutes following start-up.</p>	<ol style="list-style-type: none"> 1. Power supply problem. 2. Tripped internal disconnect. 3. Shut off by external thermostat or thermostat is defective. 4. Unit off on high pressure or loss of charge. 5. Internal component or connection failure. 	<ol style="list-style-type: none"> 1. Check power supply for adequate phase and voltage. Check wiring to unit and external breakers or fuses. 2. Check circuit protection devices for continuity. 3. Check operation of wall-mounted thermostat. 4. Reset lockout. See section 1.4. 5. Check for loose wiring. Check components for failure.
<p>B. Unit runs for long periods or continuously; cooling is insufficient.</p>	<ol style="list-style-type: none"> 1. Unit undersized for job. 2. Low refrigerant. 3. Component failure. 4. Dirty filter or reduced airflow. 	<ol style="list-style-type: none"> 1. Add additional units for greater capacity. 2. Check for proper charge and possible refrigerant leak. 3. Check internal components, especially compressor for proper operation. 4. Check air filter(s). Check blower operation. Remove airflow restriction.
<p>C. Unit cycles on high pressure or loss of charge.</p>	<ol style="list-style-type: none"> 1. Loss or restriction of airflow. 2. Restriction in refrigerant circuit. 3. Refrigerant overcharge (following field service) 4. Defective high pressure control or loss of charge switch. 	<ol style="list-style-type: none"> 1. Check blower assembly for proper operation. Look for airflow restrictions, e.g., the air filter. Check blower motor and condenser fan. Indoor blower fan speed control set too low. 2. Check for blockage or restriction, especially filter drier and capillary tube assembly. 3. Evacuate and recharge to factory specifications. 4. Check limit cutout pressures. Control is set to actuate at approximately 40 PSIG (loss of charge) and 610 PSIG (high pressure).
<p>D. Unit blows fuses or trips circuit breaker.</p>	<ol style="list-style-type: none"> 1. Inadequate circuit ampacity. 2. Short, loose, or improper connection in field wiring. 3. Internal short circuit. Loose or improper connection(s) in unit. 4. Excessively high or low supply voltage or phase loss (3Ø only). 	<ol style="list-style-type: none"> 1. Note electrical requirements in Chapter 2 and correct as necessary. 2. Check field wiring for errors. 3. Check wiring in unit. See wiring and schematic diagrams. Test components (especially the compressor) for shorts. 4. Note voltage range limitations specific to the compressor troubleshooting section.

PROBLEM/SYMPTOM	LIKELY CAUSE(S)	CORRECTION
E. Water on floor near unit.	1. Obstruction in condensate line. 2. Obstruction or leak in condensate pan. 3. Unit is not level.	1. Check for clog or restriction. 2. Check pan for leak or blockage. 3. Level unit.
F. No space heating or reduced heating (units equipped with resistance elements)	1. Defective heating element(s). 2. Thermal limit open. 3. Defective heater contactor. 4. Thermostat set too low. 5. Compressor fault.	1. Check resistance element(s) for continuity. 2. Check continuity across thermal limit switch. 3. Check relay for proper operation. Replace if defective. 4. Adjust thermostat. 5. Reset the lock out relay at the thermostat.

5.3 Compressor Troubleshooting

Obtain the heat pump's model number and serial number, the compressor's model number and contact Airxcel Commercial Group for compressor specifications.

It is important to rule out other component failures before condemning the compressor.

The following electrical tests will aid diagnosis on single phase units:

1. **Start-Up Voltage:** Measure the voltage at the compressor contactor during start-up. The voltage must exceed the minimum shown in Table 8, section 2.2, or compressor failure is likely. A low voltage condition must be corrected.
2. **Running Amperage:** Connect a clip-on type ammeter to the (common) lead to the compressor. Turn on the supply voltage and energize the unit. The compressor will initially draw high amperage; it should soon drop to the RLA value or less. If the amperage stays high, check the motor winding resistances.

NOTE: Feel the top of the compressor to see if it has overheated. If it is hot, the internal overload may be open. You may have to wait several hours for it to reset.

3. **High Voltage/Insulation Test:** Test internal leakage with a megohmmeter. Attach one lead to the compressor case on a bare metal tube and to each compressor terminal to test the motor windings. A short circuit at a high voltages indicates a motor defect. Do not do this test under vacuum.
4. On single phase models, check the capacitor by substitution.

5.4 Control Board Diagnosis

The PCB is equipped with an on board seven-segment display (see Section 2.3) for configuring various settings and displaying faults. During normal operation the display remains off unless the configuration menu is accessed or a fault has occurred. Faults will be annunciated on the display as shown below:

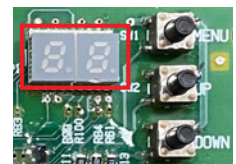

Display	Displayed Faults
AS-F	Supply Air Sensor Fault (Sensor Disconnected Or Faulty) If Equipped
DB-F	Dry Bulb / Outdoor Sensor Fault (Sensor Disconnected Or Faulty) If Equipped
DS-F	Defrost Sensor Fault (Sensor Disconnected Or Faulty) Heat Pumps Only
ES-F	Enthalpy Sensor Fault (Sensor Disconnected Or Faulty) If Equipped
EF	Emergency Fan / Ventilation Active
Lc	Loss of Refrigerant / Flat Unit Fault
LP-1	Low Pressure Lockout Compressor Circuit 1
LP-2	Low Pressure Lockout Compressor Circuit 2
HP-1	High Pressure Lockout Compressor Circuit 1
HP-2	High Pressure Lockout Compressor Circuit 2
03	Low Voltage "Brownout" 16VAC or Less for 10 Minutes

5.5 Electric Heat Controls

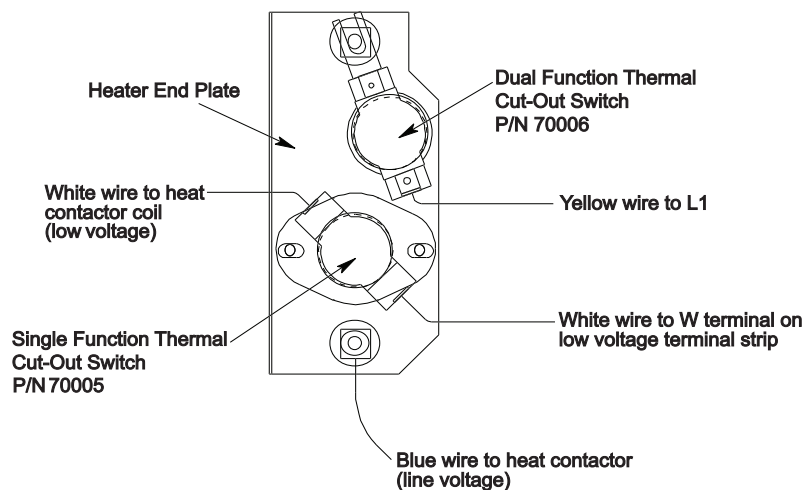

Figure 9 - Typical Configuration for Single Element Heater

The electric heater assembly can have up to three individual heating elements. Each individual heating element is protected against overheating by its own dual function thermal cut-out switch. Additionally, a separate single function thermal cut-out switch protects the entire heater assembly.

The dual function thermal cut-out switch (P/N 70006) is composed of two independent line voltage snap-disc temperature switches mounted in a single enclosure. One of these switches is an automatic reset device which cycles off at approximately 145°F and back on at approximately 115°F. Should this switch fail to open, the second switch will open the circuit if the temperature continues to increase. This second switch does not reset. If it opens (breaks the line voltage circuit to the heater assembly) the switch will have to be replaced by qualified service personnel after the source of the overheat problem is resolved.

In addition to the thermal cut-out switch described above, there is a single function thermal cut-out switch (P/N 70005) mounted on the heater frame. This switch controls the 24V AC control current to the heater contactor(s) which powers all the heating elements. This single function thermal cut-out switch operates totally independent of the dual thermal cut-out switch described above. If the single function switch senses an overheat situation, it opens the control circuit and turns off all of the installed heating elements via the heater contactor(s). Because this switch controls the heater contactor(s), only one switch is required to disconnect power from the contactor(s), regardless of the number of heater elements. This single function switch is also non-resettable, and must be replaced by qualified service personnel after the source of the overheat problem is resolved. This switch would typically open if both elements of the dual thermal cut-out switches failed.

Chapter 6 Electrical Schematics

6.1 Electrical Schematics

The compressor and condenser fan are energized with a contactor controlled by a 24 VAC pilot signal.

The condenser (outside fan) motor is energized by the same contactor. However, the motor is cycled on and off by the low ambient control (see low ambient control 1.5). **Note:** Only on heat pumps equipped with an economizer.

The compressor incorporates an internal PTC crankcase heater that functions as long as primary power is available. The heater drives liquid refrigerant from the crankcase and prevents loss of lubrication caused by oil dilution. Power must be applied to the unit for 24 hours before starting the compressor. **Note:** Heat pumps with scroll compressors generally do not require crankcase heaters.

The indoor evaporator fan motor is cycled by the blower timed delay relay. See Figure 9. Due to the large number of variations and options available for the Marvair heat pumps, it is not practical to include every possible wiring schematic in this manual. The following schematics are typical. Included in each heat pump is the electrical schematic for that unit. Always refer to the schematic in the unit when installing or servicing the heat pump.

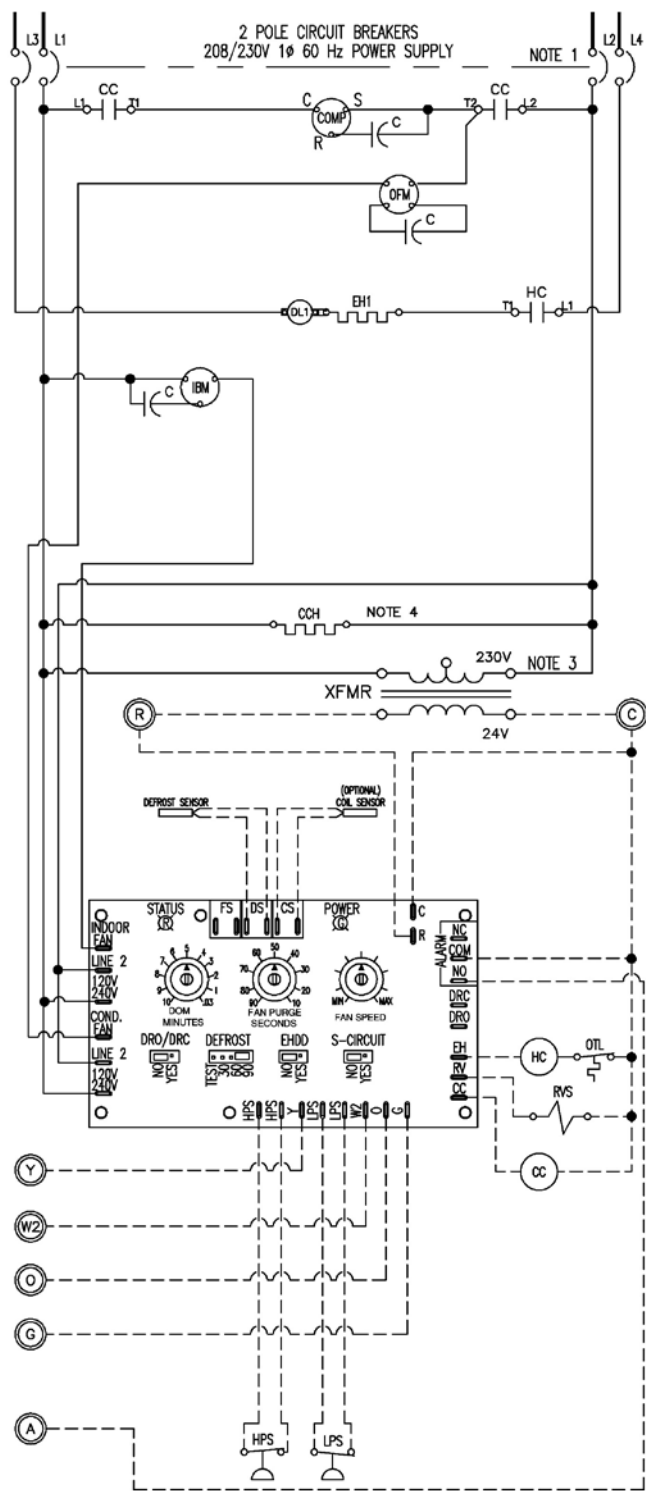

ELECTRICAL LEGEND:

- C CAPACITOR
- CC COMPRESSOR CONTACTOR
- CCH CRANKCASE HEATER
- COMP COMPRESSOR
- DL DUAL LIMIT
- EH ELECTRIC STRIP HEATER
- HPS HIGH PRESSURE SWITCH
- HC HEAT CONTACTOR
- IBM INDOOR BLOWER MOTOR
- LPS LOW PRESSURE SWITCH
- OFM OUTDOOR FAN MOTOR
- OTL ONE TIME LIMIT
- RVS REVERSING VALVE SOLENOID
- XFMR TRANSFORMER

VOLTAGE LEGEND

- LINE VOLTAGE FACTORY
- LINE VOLTAGE FIELD
- LOW VOLTAGE FACTORY
- LOW VOLTAGE FIELD
- - - - - ALT. VOLTAGE (FIELD SPEC.)

COLOR CODE

- BK - BLACK
- BL - BLUE
- BR - BROWN
- G - GREEN
- O - ORANGE
- R - RED
- Y - YELLOW
- WHT - WHITE
- BK/RED - BLACK, RED STRIPE

GENERAL NOTES:

1. 208/230 VOLT 1φ 60 Hz POWER SUPPLY. SEE DATA PLATE FOR AMPACITY AND FUSE SIZE. OPTIONAL CKT BKR SHOWN.
2. SPEED TAP - SEE MOTOR NAMEPLATE FOR WIRE COLORS.
3. TRANSFORMER IS FACTORY WIRED FOR 230 VOLT OPERATION. FOR LOWER VOLTAGES, INTERCHANGE ORANGE AND RED LEADS. INSULATE UNUSED LEADS.
4. CCH MAY NOT BE REQUIRED ON ALL MODELS.
5. PTCR IS NOT REQUIRED ON ALL COMPRESSORS.
6. THE (STATUS LED) WILL BLINK ONE TIME AFTER THE HPS (HIGH PRESSURE SWITCH) HAS OPENED TWICE AND THE UNIT WILL LOCKOUT.
7. THE (STATUS LED) WILL BLINK TWICE AFTER THE LPS (LOW PRESSURE SWITCH) HAS OPENED TWICE AND THE UNIT WILL LOCKOUT. THE LOCKOUT CIRCUIT CONTACTS ARE LOCATED ON THE PRINTED CIRCUIT BOARD.
8. THE (STATUS LED) WILL BLINK FOUR TIMES TO INDICATE A DEFOST OR COIL SENSOR FAULT AND THE UNIT WILL CONTINUE TO OPERATE.

Figure 10a - Typical 1φ Electrical Schematic Diagram Heat Pump (Models MAA) with Manual Outside Air Damper

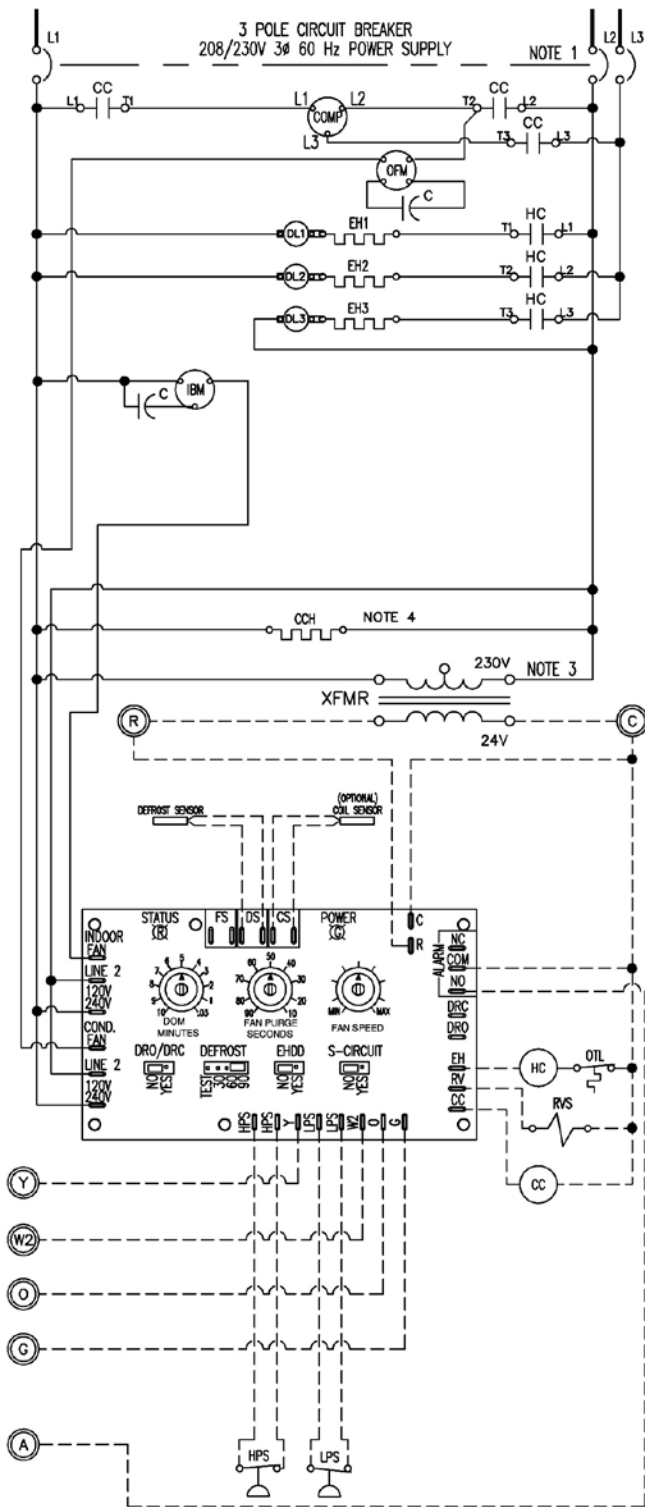

ELECTRICAL LEGEND:

- C CAPACITOR
- CC COMPRESSOR CONTACTOR
- CCH CRANKCASE HEATER
- COMP COMPRESSOR
- DL DUAL LIMIT
- EH ELECTRIC STRIP HEATER
- HPS HIGH PRESSURE SWITCH
- HC HEAT CONTACTOR
- IBM INDOOR BLOWER MOTOR
- LPS LOW PRESSURE SWITCH
- OFM OUTDOOR FAN MOTOR
- OTL ONE TIME LIMIT
- RVS REVERSING VALVE SOLENOID
- XFMR TRANSFORMER

VOLTAGE LEGEND

- LINE VOLTAGE FACTORY
- LINE VOLTAGE FIELD
- LOW VOLTAGE FACTORY
- LOW VOLTAGE FIELD
- ALT. VOLTAGE (FIELD SPEC.)

COLOR CODE

- BK - BLACK
- BL - BLUE
- BR - BROWN
- G - GREEN
- O - ORANGE
- R - RED
- Y - YELLOW
- WHT - WHITE
- BK/RED - BLACK, RED STRIPE

GENERAL NOTES:

1. 208/230 VOLT 3 ϕ 60 Hz POWER SUPPLY. SEE DATA PLATE FOR AMPACITY AND FUSE SIZE. OPTIONAL CKT BKR SHOWN.
2. FACTORY PROGRAMMED ECM MOTOR.
3. TRANSFORMER IS FACTORY WIRED FOR 230 VOLT OPERATION. FOR LOWER VOLTAGES, INTERCHANGE ORANGE AND RED LEADS. INSULATE UNUSED LEADS.
4. CCH MAY NOT BE REQUIRED ON ALL MODELS
5. PTCR IS NOT REQUIRED ON ALL COMPRESSORS.
6. THE (STATUS LED) WILL BLINK ONE TIME AFTER THE HPS (HIGH PRESSURE SWITCH) HAS OPENED TWICE AND THE UNIT WILL LOCKOUT.
7. THE (STATUS LED) WILL BLINK TWICE AFTER THE LPS (LOW PRESSURE SWITCH) HAS OPENED TWICE AND THE UNIT WILL LOCKOUT. THE LOCKOUT CIRCUIT CONTACTS ARE LOCATED ON THE PRINTED CIRCUIT BOARD.
8. THE (STATUS LED) WILL BLINK FOUR TIMES TO INDICATE A DEFROST OR COIL SENSOR FAULT AND THE UNIT WILL CONTINUE TO OPERATE.

Figure 10b - Typical 208/230v. 3 ϕ Electrical Schematic Diagram Heat Pump (Models MAA)

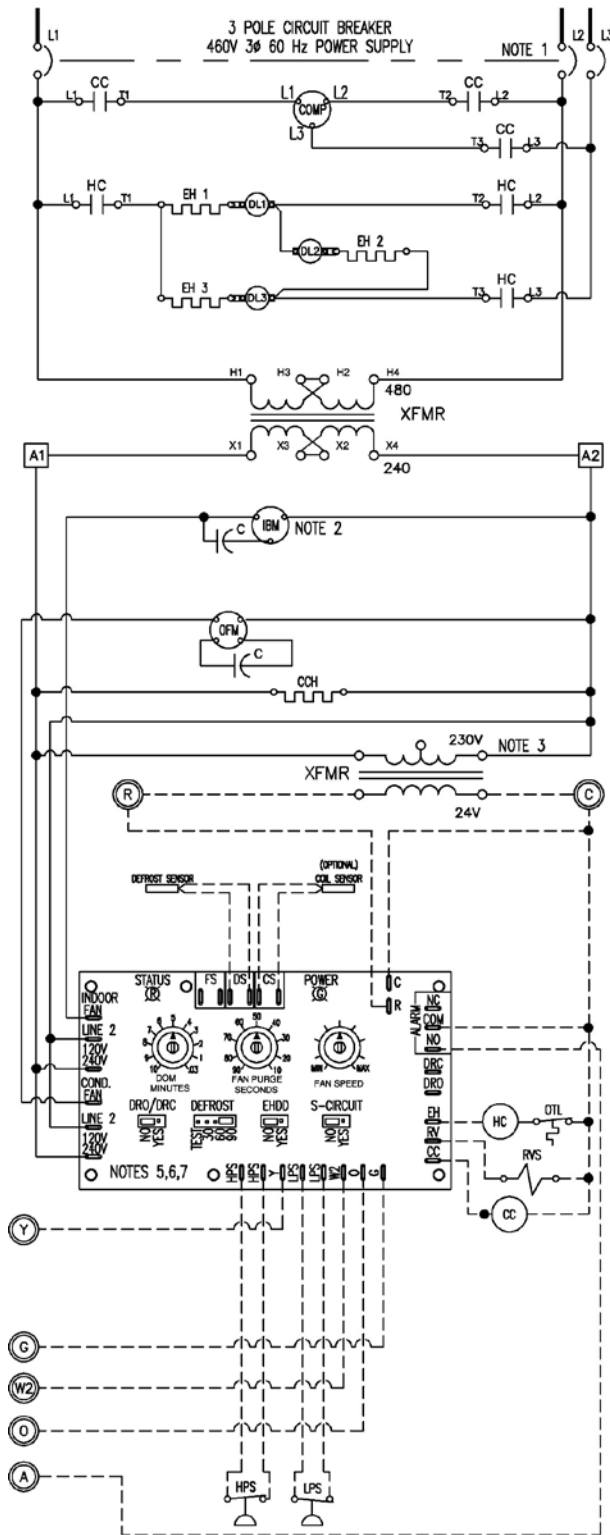

ELECTRICAL LEGEND:

- C CAPACITOR
- CC COMPRESSOR CONTACTOR
- CCH CRANKCASE HEATER
- COMP COMPRESSOR
- DL DUAL LIMIT
- EH ELECTRIC HEAT
- HC HEAT CONTACTOR
- HPS HIGH PRESSURE SWITCH
- IBM INDOOR BLOWER MOTOR
- LPS LOW PRESSURE SWITCH
- OFM OUTDOOR FAN MOTOR
- OTL ONE TIME LIMIT
- RVS REVERSING VALVE SOLENOID
- XFMR TRANSFORMER

VOLTAGE LEGEND

- LINE VOLTAGE FACTORY
- LINE VOLTAGE FIELD
- - - - - LOW VOLTAGE FACTORY
- - - - - LOW VOLTAGE FIELD
- - - - - ALT. VOLTAGE (FIELD SPEC.)

COLOR CODE

- BK - BLACK
- BL - BLUE
- BR - BROWN
- G - GREEN
- O - ORANGE
- R - RED
- Y - YELLOW
- WHT - WHITE
- BK/RED - BLACK, RED STRIPE

GENERAL NOTES:

1. 460 VOLT 3 ϕ 60 Hz POWER SUPPLY. SEE DATA PLATE FOR AMPACITY AND FUSE SIZE. OPTIONAL CKT BKR SHOWN.
2. SPEED TAP - SEE MOTOR NAMEPLATE FOR WIRE COLORS.
3. TRANSFORMER IS FACTORY WIRED FOR 230 VOLT OPERATION. FOR LOWER VOLTAGES, INTERCHANGE ORANGE AND RED LEADS. INSULATE UNUSED LEADS.
4. CRANKCASE MAY NOT BE REQUIRED ON ALL COMPRESSORS.
5. THE (STATUS LED) WILL BLINK ONE TIME AFTER THE HPS (HIGH PRESSURE SWITCH) HAS OPENED TWICE AND THE UNIT WILL LOCKOUT.
6. THE (STATUS LED) WILL BLINK TWICE AFTER THE LPS (LOW PRESSURE SWITCH) HAS OPENED TWICE AND THE UNIT WILL LOCKOUT. THE LOCKOUT CIRCUIT CONTACTS ARE LOCATED ON THE PRINTED CIRCUIT BOARD.
7. THE (STATUS LED) WILL BLINK FOUR TIMES TO INDICATE A DEFROST OR COIL SENSOR FAULT AND THE UNIT WILL CONTINUE TO OPERATE.

Figure 10c - Typical 460v. 3 ϕ Electrical Schematic Diagram Heat Pumps, Models MAA, with the PC Control Board

Chapter 7 Maintenance

7.1 Scheduled Maintenance

Marvair, Inc. strongly recommends that the heat pump be serviced a minimum of twice a year – once prior to the heating season and once prior to the cooling season. At this time the filters, evaporator coil, condenser coil, the cabinet, and condensate drains should be serviced as described below. Also at this time, the heat pump should be operated in the cooling and heating cycles as described in Chapter 3, Start-Up. In addition to this seasonal check-out, the unit should be maintained as follows:

Air Filter

Replace the air filter whenever it is visibly dirty. Never operate the heat pump without the filters in place.

Indoor Coil

If the coil becomes clogged or dirty, it may be cleaned by careful vacuuming or with a commercial evaporator cleaning spray. DO NOT use a solvent containing bleach, acetone, or flammable substances. Turn power OFF before cleaning. Be careful not to wet any of the electrical components. Be sure the unit has dried before restarting. Use a fin comb of the correct spacing to straighten mashed or bent fins.

Outdoor Coil

Periodically inspect the outdoor coil and the cabinet air reliefs for dirt or obstructions. Remove foreign objects such as leaves, paper, etc.

If the coil is dirty, it may be washed off with a commercial solvent intended for this purpose. TURN OFF POWER BEFORE CLEANING! Be sure that all electrical components are thoroughly dry before restoring power.

Cabinet

The cabinet may be cleaned with a sponge and warm, soapy water or a mild detergent. Do not use bleach, abrasive chemicals or harmful solvents.

Drains

Regularly check the condensate drain. If a commercial drain solvent is used, flush out the drain pan and system with plenty of fresh water to prevent corrosion.

Lubrication

Oiling of the condenser fan motor or the evaporator blower motor is not recommended.

Chapter 8 Warranty

8.1 Marvair, Inc. Limited Product Warranty

Marvair Inc., warrants its products to be free from defects in materials and workmanship under normal use to the original purchaser for the period of time in the table below. If any part of your product fails within 12 months from start-up, or 18 months from shipment from the factory, whichever comes first, Marvair, Inc. will furnish without charge, EXW Cordele, Georgia, the required replacement part. The owner must provide proof of the date of the original start-up. The contractor's invoice, the certificate of occupancy, or similar documents are examples of acceptable proof of the date of the original start-up.

Marvair, ICE, Eubank Products
90 Days ¹ w/Flat Rate Labor ² (See <i>Marvair, ICE, Eubank Flat Rate Labor Guidelines</i>)
1 Year Parts ^{2,3}
5 Years Compressor ²

¹If any part of your Marvair, Inc. unit fails within 90 days of the commencement of the warranty, Marvair, Inc. will furnish without charge, EX Works, Cordele, Georgia, the required replacement part and pay for the labor to replace the part in accordance with the Marvair, Inc. Flat Rate Labor Guidelines.

²All OTR (over the road) applications that are moved from one location to another: Factory Warranty applies only up to the point of initial start-up and test at all OEM manufacturing locations or subsequent facility. Once it goes into OTR service, the warranty expires immediately for compressor and sealed system components. This OTR exemption does not apply to relocatable classrooms, construction or office trailers.

³All warranty replacement parts shall be shipped Ground only. Expedited shipping is available upon request for additional cost.

The responsibility of the equipment owner includes:

1. To operate the equipment in accordance with the manufacturer's instructions.
2. To provide easy accessibility for servicing.
3. To check and reset any circuit breaker(s) and/or disconnect(s) prior to calling for service.
4. To keep the unit clean and free of dirt and containment and replace filters as required.
5. To keep the outdoor coil clean and free of leaves, paper, or other debris.
6. To pay the charges incurred when any of the above have not been done.
7. To pay for repair or replacement of any material or part other than those within the Marvair unit or controller.

Marvair, Inc., will not be responsible for labor after 90 days, transportation costs, delays or failures to complete repairs caused by events beyond our control (labor hours incurred due to required site-specific training, time waiting to gain access, or extended drive time for remote sites). This warranty does not cover:

1. Any transportation, related service labor, diagnosis calls, filter, driers, refrigerant, or any other material charges.
2. Damages caused by shipping, accident, abuse, negligence, misuse, fire, flood, or Acts of God.
3. Damages caused by operating or staging the unit in a corrosive environment.
4. Damages caused by improper application of the product.
5. Damages caused by failing to perform proper routine maintenance.
6. Expenses incurred for erecting, disconnecting or dismantling the product or installing the replacement part(s).
7. Products not installed or operated according to the included instructions, local codes, and good trade practices.
8. Products moved from the original installation site.
9. Products lost or stolen
10. Consequential damages or incidental expenses including losses to persons, property or business.
11. Modifications to original unit after it leaves the factory, such as breaking into any part of the sealed systems unless authorized in advance in writing by Marvair, Inc..
12. Damages as a result of operating as a construction site cooler / dehumidifier.

When labor (first 90 days only) is required, it must be performed during normal working hours (8:00 AM - 5:00 PM) Monday - Friday and must be performed by Marvair, Inc., personnel or a designated Service Representative.

The owner of the product may ship the allegedly defective or malfunctioning product or part to Marvair, Inc., at such owner's expense, and Marvair, Inc., will diagnose the defect and, if the defect is covered under this warranty, Marvair, Inc., will honor its warranty and furnish the required replacement part. All costs for shipment and risk of loss during shipment of the product to Marvair, Inc., and back to the owner shall be the responsibility and liability of the owner. Upon written request by an owner, Marvair, Inc., may arrange for remote diagnosis of the allegedly defective or malfunctioning product or part but all costs for transportation, lodging and related expenses with regard to such diagnostic services shall be the responsibility and liability of the owner.

An owner requesting performance under this Warranty shall provide reasonable access to the allegedly defective or malfunctioning product or part to Marvair, Inc., and its authorized agents and employees.

THIS WARRANTY CONSTITUTES THE EXCLUSIVE REMEDY OF ANY PURCHASER OF A MARVAIR HEAT PUMP OR AIR CONDITIONER AND IS IN LIEU OF ALL OTHER WARRANTIES, EXPRESSED OR IMPLIED, INCLUDING, WITHOUT LIMITATION, ANY IMPLIED WARRANTY OF MERCHANTABILITY OR FITNESS FOR USE, TO THE FULLEST EXTENT PERMITTED BY LAW. IN NO EVENT SHALL ANY IMPLIED WARRANTY OF MERCHANTABILITY OR FITNESS FOR USE EXCEED THE TERMS OF THE APPLICABLE WARRANTY STATED ABOVE AND MARVAIR SHALL HAVE NO OTHER OBLIGATION OR LIABILITY. IN NO EVENT SHALL MARVAIR BE LIABLE FOR INCIDENTAL OR CONSEQUENTIAL DAMAGES OR MONETARY DAMAGES.

THIS WARRANTY GIVES YOU SPECIFIC LEGAL RIGHTS, AND YOU MAY ALSO HAVE OTHER RIGHTS WHICH VARY FROM STATE-TO-STATE. Some states do not allow limitations or exclusions, so the above limitations and exclusions may not apply to you.

04/30/2020 Rev. 9

APPENDIX A: Electronic Control Board Modbus Map

Default Modbus RTU Settings

Slave ID = 1
Baud = 19200
Data Bits = 8
Stop Bits = 1
Parity = None
 First Coil 1 , No. of Coils 30

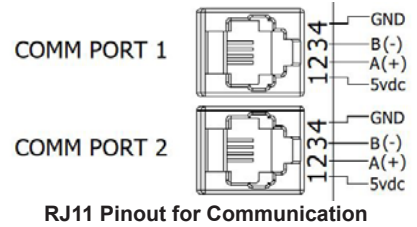

Discrete Bit/Bool: Read with Function Code 02 multi discrete input read, Write to RW coil with Function Code 05 Single Coil write. Coils and DI RO share a common space. Attempted Writes to RO DI inputs result in error return. Func 0x0F multiple coil writes not supported.

MODBUS PACKET REGISTER ZeroBase ID (ZBI)	Coil ID Value, Human OBI Reference Register ID				
OFFSET	ID	Description	Size	Data Format	R/W
0	1	Current Status of the Y1 Compressor Call	1 bit	0 = no call, 1 = call	RW
1	2	Current Status of the Y2 Compressor Call	1 bit	0 = no call, 1 = call	RW
2	3	Current Status of the Humidity Call	1 bit	0 = no call, 1 = call	RW
3	4	Current Status of the G Fan Call	1 bit	0 = no call, 1 = call	RW
4	5	Current Status of the W2 Electric Heating Call	1 bit	0 = no call, 1 = call	RW
5	6	Current Status of the FCC Call	1 bit	0 = no call, 1 = call	RO
6	7	High Pressure Switch 1 Status	1 bit	0 = Open, 1 = Closed	RO
7	8	High Pressure Switch 2 Status	1 bit	0 = Open, 1 = Closed	RO
8	9	Low Pressure Switch 1 Status	1 bit	0 = Open, 1 = Closed	RO
9	10	Low Pressure Switch 2 Status	1 bit	0 = Open, 1 = Closed	RO
10	11	OFM Mode Selection	1 bit	0 = PWM, 1 = 0-10V	RO
11	12	IFM Mode Selection	1 bit	0 = PWM, 1 = 0-10V	RO
12	13	Technician Speedup Test Mode Status	1 bit	0 = Normal Mode, 1 = Test Mode	RO
13	14	Status of Compressor 1 Relay Output	1 bit	0 = Off, 1 = Energized	RO
14	15	Status of Compressor 2 Relay Output	1 bit	0 = Off, 1 = Energized	RO
15	16	Status of RH RelayOutput	1 bit	0 = Off, 1 = Energized	RO
16	17	Status of W2 RelayOutput	1 bit	0 = Off, 1 = Energized	RO
17	18	Enables/1 or Disables/0 the communicating mode thermostat functionality. Reads/modifies parameter P22. 0=H,1=C	1 bit	0 = H hardware calls, 1 = Comm/Modbus calls.	RW
18	19	Enables or disables reading the hardware thermostat call inputs (Coils1-5,25).	1 bit	0 = Normal usage based on P22. 1 = read HW calls thermostat inputs regardless of programming of P22 as C. Default is 0, normal operations.	RW
19	20	Current Status of AC / HP	1 bit	0 = AC, 1 = HP	RO
20	21	Current Status of EHDD	1 bit	0 = N, 1 = Y	RO
21	22	Current Status of SCKT	1 bit	0 = N, 1 = Y	RO
22	23	Current Status of Enable Economizer	1 bit	0 = N, 1 = Y	RO
23	24	Current Status of Economizer Sensor Type	1 bit	0 = DB, 1 = EN	RO
24	25	Current Status of O Reversing Valve request	1 bit	0 = no call, 1 = call	RW
25	26	Current Status of RV output	1 bit	0 = OFF, 1 = Energized	RO
26	27	Emergency Ventilation Request	1 bit	0 = Off, 1 = Energized	RW
27	28	Pulse Reheat	1 bit	0 = off, 1 = ON (default)	RW
28	29	Status of Emergency Ventilation	1 bit	0 = Off, 1 = ON	RO
29	30	Status of EC relay output.	1 bit	0 = Off, 1 = ON	RO

Registers: Read with Function Code 04 Multi register reads, Write to RW register with Function Code 06 write single register. Attempted Writes to RO registers result in error return. Func 0x10 multiple register writes not supported.					
MODBUS PACKET REGISTER ZeroBase ID (ZBI)	Human OBI Register ID				
	ID	Description	Size	Data Format	R/W
0	40001	Heat Setpoint Note: Register is RW but not currently used. For future use.	16 bit	45-100 degrees Fahrenheit	RW
1	40002	Cool Setpoint Note: Register is RW but not currently used. For future use.	16 bit	45-100 degrees Fahrenheit	RW
2	40003	Temperature Calibration	16 bit	0-18, 9 is default. Less than 9 is a negative offset, 10-18 is a positive offset. Value minus 9 is the correction.	RW
3	40004	W2 Speed Multiplier	16 bit	0-100, 80 is default. Represents a percentage of the Y2 fan speed	RW
4	40005	Dehumidification Speed Multiplier	16 bit	0-100, 80 is default. Represents a percentage of the Y2 fan speed	RW
5	40006	OFM Set Speed	16 bit	0 - 1023	RW
6	40007	IFM Y1 Set Speed	16 bit	0 - 1023	RW
7	40008	IFM Y2 Set Speed	16 bit	0 - 1023	RW
8	40009	Modbus Timeout Setting	16 bit	1 - 60, default 10; represents minutes of allowed modbus inactivity before switching to HW call onboard t-stat mode	RW
9	40010	Current OFM Speed	16 bit	0 - 1023	RO
10	40011	Current IFM Speed	16 bit	0 - 1023	RO
11	40012	Anti Short Cycle Compressor 1	16 bit	0 - 360, 0.5 seconds per step	RO
12	40013	Anti Short Cycle Compressor 2	16 bit	0 - 360, 0.5 seconds per step	RO
13	40014	Voltage Reading	16 bit	0-1023, 1023 = Greater than 20V 965 = 18V cutoff	RO
14	40015	P1 Temperature Reading	16 bit	0-160 degrees Fahrenheit, 255 no sensor	RO
15	40016	P2 Temperature reading	16 bit	0-160 degrees Fahrenheit, 255 no sensor	RO
16	40017	Freeze Sensor 1 Temperature Reading	16 bit	0-160 degrees Fahrenheit, 255 no sensor	RO
17	40018	Freeze Sensor 2 Temperature Reading	16 bit	0-160 degrees Fahrenheit, 255 no sensor	RO
18	40019	Alarm Status	16 bit	0 = No Fault D0 = FLAT CIRCUIT FAULT D1 = HPS1 Fault D2 = Low Voltage D3 = Future Use D4 = Future Use D5 = Future Use D6 = LPS1 Fault D7 = Future Use D8 = Future Use D9 = Future Use D10 = Future Use D11 = Future Use D12 = Future Use D13 = Future Use D14 = Y1 Locked Out D15 = Y2 Locked Out	RO

19	40020	Current Status of MIN POS	16 bit	20 = MIN, 20-100= OPEN %	RW
20	40021	Economizer Dry Bulb Temperature setpoint	16 bit	70F=default, 20F-105F	RW
21	40022	ODS set	16 bit	50 default, 0-70	RW
22	40023	Fan Purge	16 bit	N= 0, 10-90 SECONDS, 90 SEC IS DEFAULT	RW
23	40024	Defrost Timer	16 bit	30= default, 30, 60, 90 minutes	RW
24	40025	Current SW version number	16 bit	display sw version decimal	RO
25	40026	Supply/Mixed Air Temp reading	16 bit	0-160 degrees Fahrenheit	RO
26	40027	SAS/MAS calibration	16 bit	0-18, 9 is default. Less than 9 is a negative offset, 10-18 is a positive offset. Value minus 9 is the correction.	RW
27	40028	Outdoor Temp reading	16 bit	0-160 degrees Fahrenheit	RO
28	40029	ODS Calibration	16 bit	0-18, 9 is default. Less than 9 is a negative offset, 10-18 is a positive offset. Value minus 9 is the correction.	RW
29	40030	LPS1 / Suction Line Temp reading	16 bit	0-160 degrees Fahrenheit, 255 if open or shorted sensor	RO
30	40031	Suction Line Temp Calibration	16 bit	0-18, 9 is default. Less than 9 is a negative offset, 10-18 is a positive offset. Value minus 9 is the correction.	RW
31	40032	FCC1 / Liquid Line temp reading	16 bit	0-160 degrees Fahrenheit, 255 if open or shorted sensor	RO
32	40033	Liquid Line temp Calibration	16 bit	0-18, 9 is default. Less than 9 is a negative offset, 10-18 is a positive offset. Value minus 9 is the correction.	RW
33	40034	DS Temp (defrost sensor temp) reading	16 bit	0-160 degrees Fahrenheit	RO
34	40035	DS calibration	16 bit	0-18, 9 is default. Less than 9 is a negative offset, 10-18 is a positive offset. Value minus 9 is the correction.	RW
35	40036	Dehumidifier Setpoint	16 bit	Default 72 F, 70 - 75F	RW
36	40037	Pulse Reheat Differential	16 bit	Default 5 F, 5 - 10F	RW
37	40038	Economizer setpoint Entropy Mode A..E as 0..4	16 bit	Default 3/D	RW
38	40039	ECO output status	16 bit	0 = off, 20-100	RO

APPENDIX B: Installation Instructions for Field Installed Electric Heat

WARNING **FIRE HAZARD**

Improper adjustment, alteration, service, maintenance or installation could cause serious injury, death and/or property damage.

Installation or repairs made by unqualified persons could result in hazards to you and others. Installation **MUST** conform with local codes or, in the absence of local codes, with codes of all governmental authorities have jurisdiction.

The information contained in this manual is intended for use by a qualified service agency that is experienced in such work, is familiar with all precautions and safety procedures required in such work, and is equipped with the proper tools and test instruments.

Duct Work

General Information

Note: The following instructions are for general guidance only. Due to the wide variety of installation possibilities, specific instructions will not be given. When in doubt, follow standard and accepted installation practices, or contact Marvair for additional assistance.

Wall Openings

Measure the dimensions of the supply and return ports on the unit.

Cut the openings in the exterior wall for the supply and return. **IMPORTANT: All units with electric heat must have 1" (25.4 mm) clearance on all four sides of the supply outlet duct flange on the unit. The 1" (25.4 mm) clearance must extend on all sides of the supply duct for the first 3 feet (1 meter) from the unit.**

IMPORTANT: Marvair requires a minimum of 1" (25.4 mm) from the surface of any supply ducts to combustible material for the first 3 feet (1 meter) of the duct.

Ducting

Extensions should be cut flush with the inside wall for applications without duct work.

Applications using duct work should be designed and installed in accordance with all applicable safety codes and standards. Marvair strongly recommends referring to the current edition of the National Fire Protection Association Standards 90A and 90B before designing and installing duct work. The duct system must be engineered to insure sufficient air flow through the unit to prevent over-heating of the heater element. This includes proper supply duct sizing, sufficient quantity of supply registers, adequate return and filter area. Ductwork must be of correct material and must be properly insulated. Duct work must be constructed of galvanized steel with a minimum thickness of .019 inches for the first 3 feet (1 meter). Ductwork must be firmly attached, secured and sealed to prevent air leakage. Do not use duct liner on inside of supply duct within 4 feet (122 cm) of the unit. Galvanized metal duct extensions should be used to simplify connections to duct work and grilles. Use fabric boots to prevent the transmission of vibration through the duct system. The fabric must be U.L. rated to a minimum of 197°F (92°C).



WARNING
ELECTRICAL SHOCK HAZARD

Failure to follow safety warnings exactly could result in serious injury, death, and/or property damage.

Turn off electrical power at fuse box or service panel BEFORE making any electrical connections and ensure a proper ground connection is made before connecting line voltage.

Heater installation (see drawings and wiring diagram)

1. Remove top front panel.
2. Remove bottom front panel.
3. Remove the control box cover.
4. Remove the heater access cover plate on the upper right side of the unit by removing the three screws. Cut insulation on two sides and fold down out of way.
5. Slide new heater assembly into place by lining up stem with hole on far end. Make sure stem of new heater assembly is inserted into correct hole. The hole nearest to the indoor coil is for three element heaters and the farthest away from indoor coil is for all other heaters.
6. Install the two No. 10 screws in the heater assembly plate.
7. Install wire harness in hole provided in drain pan and then through filter bracket and then into control box.
8. Wire the heater as shown in the wiring diagram provided with the heater kit (the insulated terminal ends are to be connected at the heater).
9. Install pop tie in appropriate hole in back panel to secure wire.
10. Install closed cell strip around wires where they pass through the drain pan.
11. Reinstall the heater access cover.
12. Mount the heat contactor inside the control box where the mounting holes are provided for the heat contactor.
13. Make the wiring connections inside the control box as shown in the wiring diagram provided with the heater kit. Bundle loose wires with wire ties.
14. With a permanent marker, place an (X) in the space provided next to the heater kit rating of the installed heater on the unit data label.
15. Place the wiring diagram provided with the heater kit inside the zip lock bag which is affixed to the back side of the control box cover.
16. Replace the control box cover, the bottom front cover and the top front panel.

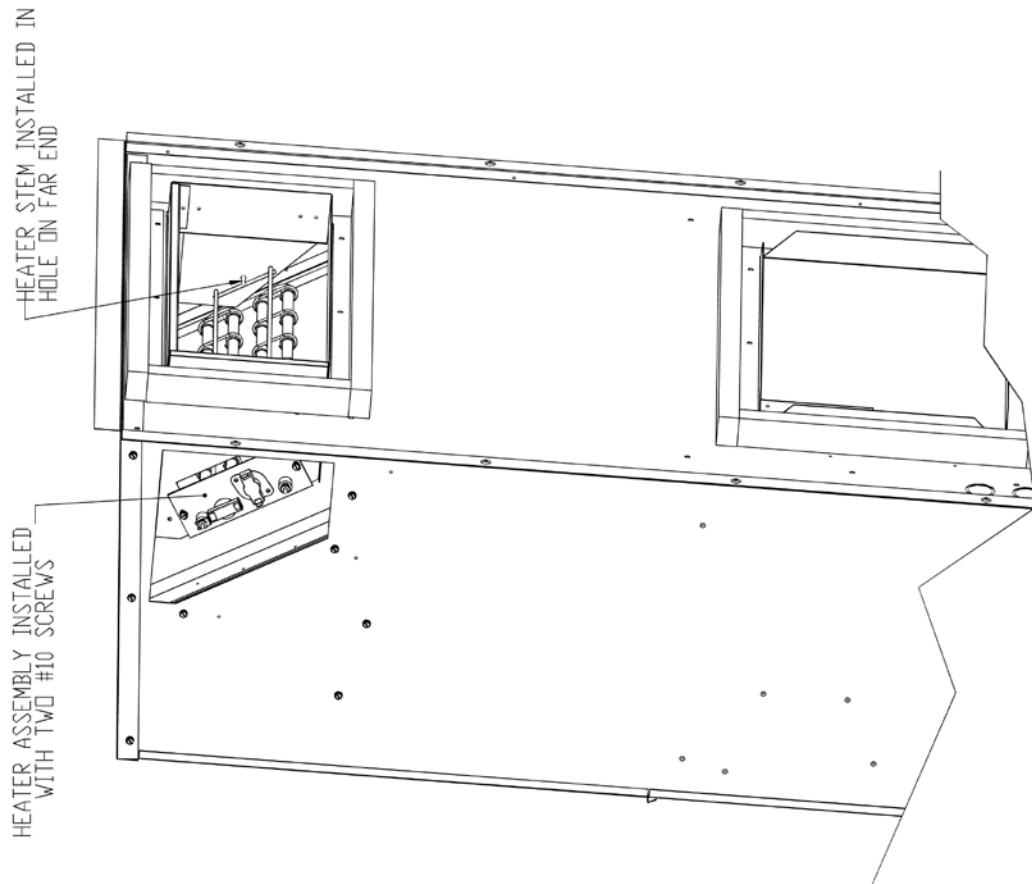
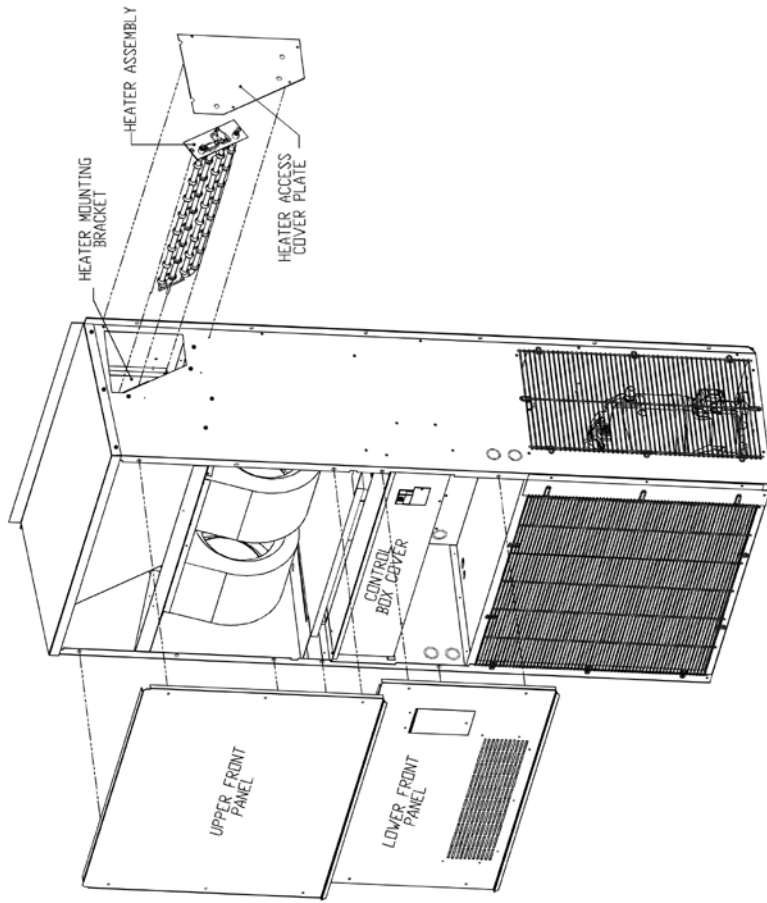

APPENDIX C: Heat Pump Start-Up - Commissioning Checklist

Please complete the information on this form and email to MarvairCustServ@airxc.com.

Date: ____ / ____ / ____

A. Owner & Location

Equipment Owner: _____

Address: _____

City: _____

State: _____, Zip: _____

B. Installing Contractor

Company: _____ Installer: _____

Address: _____

City: _____

State: _____, Zip: _____

C. Equipment Information

Unit Model No.: _____

Unit Serial No.: _____

Compressor Model No.: _____

Compressor Serial No.: _____

D. Pre-Start Up

Is there shipping damage? Yes No

If so, describe? _____

Will this damage prevent starting the unit? Yes No

Incoming Power

✓ Has Power been connected? Yes No

✓ Has the ground wire been connected? Yes No

✓ Has the circuit protection been sized and installed properly? Yes No

Controls

✓ Has the thermostat / control been connected and verified? Yes No

✓ Are all wiring terminals (including main power supply) tight? Yes No

✓ If unit has a crankcase heater, has it been energized for 24 hours? Yes No

✓ Has the correct voltage been selected on the control transformer (24vac)? Yes No

Condensate

✓ Has primary drain tube been properly place thru the opening in the bottom of the unit? Yes No

✓ Has water been placed in drain pan to confirm proper drainage? Yes No

✓ Is the correct filter(s) in place and clean? Yes No

Refrigerant Piping

✓ Is there any evidence of refrigerant leaks (oil leaks, etc.)? Yes No

If leaks are found, report them to Marvair Warranty Service Dept.

E. Check Incoming Power at Terminal Block and verify Proper Voltage and Balance BEFORE STARTING UNIT.

- 208/230V 1 Phase 60 Hz. 208/230V 3 Phase 60 Hz. 460V 3 Phase 60 Hz.
 380V 3 Phase 50Hz. 575 3 Phase 60 Hz. Other _____

Single Phase Units

- ✓ Measured Line to Line Volts L1&L2 = _____ V.
✓ Is incoming voltage between Min and Max voltage listed on unit Data Label? Yes No
An incoming voltage that is Not between the Minimum and Maximum listed on the unit Data Label Must be addressed and corrected before placing the unit into full time operation. Improper voltage can cause the compressor to overheat and cause premature failure.

Three Phase Units

- ✓ Measured Line to Line Volts L1&L2 _____ V., L1&L3 _____ V., L2&L3 _____ V.
✓ Is incoming voltage between Min and Max voltage listed on unit Data Label? Yes No
An incoming voltage that is Not between the Minimum and Maximum listed on the unit Data Label Must be addressed and corrected before placing the unit into full time operation. Improper voltage can cause the compressor to overheat and cause premature failure.

- ✓ Measured Line to Line Balance
✓ Is incoming voltage properly balanced? (use formula below to calculate balance) Yes No

Average Voltage = (L1&L2 + L1&L3 + L2&L3)/3 = _____ V.

Deviation Difference = Average Voltage - Maximum Deviation = _____ V.

Voltage Imbalance = (Deviation Difference x 100)/ Average Voltage = _____ %

A Voltage Imbalance greater than 2% with the unit running must be addressed and corrected. Excess Line to Line Voltage Imbalance can cause the compressor to overheat and cause premature failure.

Example:

$$\text{Voltage Imbalance} = \frac{(\text{Average Voltage} - \text{Maximum Deviation}) \times 100}{\text{Average Voltage}}$$

Measured Voltages:

L1 & L2 = 241 Volts

L1 & L3 = 243 Volts

L2 & L3 = 235 Volts

$$719 / 3 = 239.7 \text{ Volts (Average Voltage)}$$

$$239.7 \text{ (Average Voltage)} - 235 \text{ (Maximum Deviation)} = 4.7 \text{ (Deviation Difference)}$$

$$(4.7 \times 100) / 239.7 = 1.95\% \text{ Voltage Imbalance (Less than 2\% is acceptable)}$$

F. Cooling Mode (Mechanical Cooling)

Close the Compressor (Cooling) circuit breaker. Power will be applied to the thermostat / control device. Setup / Configure the control for the desired settings. Adjust the cooling setpoint so there is No demand for cooling. The unit will not be running.

Cooling Start

If using a standard thermostat, Set the Control to ON, Mode to Cooling, Fan to Auto (other controls, set appropriately for cooling mode). *Note: The reversing valve (Marvair Heat Pumps) is energized for “Cooling”. The “O” signal from the thermostat is Required.*

Adjust the cooling setpoint to approximately four degrees below the current indoor temperature. After the initial start-up delay (.3 to 5 minutes), the unit will sequence on, start cooling.

- ✓ Is the indoor blower motor (IBM) On? (if IBM fails to come on, Check Phase Monitor) Yes No
- ✓ Is the Compressor On? (if Compressor fails to come on, Check Phase Monitor).....Yes No
- ✓ Is the Condenser Fan (CFM) On? (Ambient conditions may be delay CFM).....Yes No
- ✓ Is incoming power properly Phased? (YES! If “Green LED” on Phase Monitor is On.)..Yes No

If incoming power is Not properly phased, “Red LED on Phase Monitor will be on; swap any two incoming power wires, either at the distribution panel or at the incoming power terminal block. Never rewire power wiring internal to the control box.

RECHECK Incoming Power and Voltage Balance in Cooling Mode.

- ✓ Measured Line to Line Volts L1&L2 _____ V., L1&L3 _____ V., L2&L3 _____ V.
- ✓ Is incoming voltage between Min and Max voltage listed on unit Data Label? Yes No

An incoming voltage that is Not between the Minimum and Maximum listed on the unit Data Label Must be addressed and corrected before starting unit. Improper voltage can cause the compressor to overheat and cause premature failure.

- ✓ Measured Line to Line Balance
- ✓ Is incoming voltage properly balanced? (use formula below to calculate balance) Yes No

Average Voltage = (L1&L2 + L1&L3 + L2&L3)/3 = _____ V.

Deviation Difference = **Average Voltage - Maximum Deviation** = _____ V.

Voltage Imbalance = (Deviation Difference x 100)/ Average Voltage = _____ %

A Voltage Imbalance greater than 2% with the unit running Must be addressed and corrected. Excess Line to Line Voltage Imbalance can cause the compressor to overheat and cause premature failure.

Example:

$$\text{Voltage Imbalance} = \frac{(\text{Average Voltage} - \text{Maximum Deviation}) \times 100}{\text{Average Voltage}}$$

Measured Voltages:

L1 & L2 = 241 Volts

L1 & L3 = 243 Volts

L2 & L3 = 235 Volts

$$719 / 3 = 239.7 \text{ Volts (Average Voltage)}$$

$$239.7 \text{ (Average Voltage)} - 235 \text{ (Maximum Deviation)} = 4.7 \text{ (Deviation Difference)}$$

$$(4.7 \times 100) / 239.7 = 1.95\% \text{ Voltage Imbalance (Less than 2\% is acceptable)}$$

Cooling (Check and Record Readings)

After about 10 minutes of operating in the cooling mode, check and record the following data points.

Inside Temperature (IAT)	_____ °F
Outside Temperature (OAT)	_____ °F
Entering Condenser Air Temperature (Should be same temp as OAT)	_____ °F
Leaving Condenser Air Temperature (Acceptable Range 15° - 20° above OAT)	_____ °F
Return Air Temperature (RAT) db (Should be same temp as IAT)	_____ °F
Return Air Temperature (RAT) wb (used to calculate RH% of Return Air)	_____ °F
Supply Air Temperature (SAT) db (Acceptable Range 15° - 20° below RAT)	_____ °F
Return Air Temperature (SAT) wb (used to calculate RH% of Supply Air)	_____ °F
Compressor Amps (L1)	_____ °F
Compressor Amps (L2)	_____ °F
Compressor Amps (L3)	_____ °F

Cooling Stop

Adjust the cooling setpoint to approximately two degrees above the current indoor temperature. The unit will sequence off, stop cooling.

- ✓ Did the Compressor stop? Yes No
- ✓ Did the Condenser Fan (CFM) stop? Yes No
- ✓ Did the indoor blower motor (IBM) Stop? Yes No

G. Electric Reheat Mode

NOTE: If the HVAC system you are testing is not configured with Dehumidification Option, Skip this section of the Start-up / Commissioning Checklist.

- ✓ Has the Humidistat Control been installed & wired to the Dehumidification input? Yes No
- ✓ Has the Humidistat Control been properly setup for dehumidification? Yes No

Adjust the cooling setpoint so there is No demand for cooling. Adjust the Humidity setpoint so there is No demand for dehumidification. The unit will not be running.

Electric Reheat Start

Adjust the Humidity setpoint to approximately ten percent below the current indoor Humidity (Humidistat display should indicate current RH%). After the short delay, the unit will sequence on, start dehumidifying.

- ✓ Is the indoor blower motor (IBM) On? Yes No
- ✓ Is the Compressor On? Yes No
- ✓ Is the Condenser Fan (CFM) On? (Ambient conditions may delay CFM)..... Yes No
- ✓ Is the Heater On? (Clamp an AmpProbe on one leg of the heater contactor to verify) Yes No

Electric Reheat Lock-Out

While the system is still operating in “Dehumidification Mode”. Activate Mechanical Cooling.

Do Not change the Humidity Setpoint on the Humidistat. Simply adjust the cooling setpoint to approximately four degrees below the current indoor temperature. After the short delay, the unit will sequence on, start cooling. Notice: system did not turn off. The Only change that occurred is “Heater turned off”.

- ✓ Is the indoor blower motor (IBM) On? Yes No
- ✓ Is the Compressor On? Yes No
- ✓ Is the Condenser Fan (CFM) On? Yes No
- ✓ Is the Heater Off? (Clamp an AmpProbe on one leg of the heater contactor to verify) ... Yes No

Electric Reheat Re-Start

While the system is still operating in “Cooling Mode” from the previous test. Re-Start Dehumidification.

Do Not change the Humidity Setpoint on the Humidistat. Simply adjust the cooling setpoint to approximately four degrees above the current indoor temperature. After the short delay, the unit will sequence on, start dehumidification. Notice: system did not turn off. The Only change **that occurred** is “Heater turned on”.

- ✓ Is the indoor blower motor (IBM) On?..... Yes No
- ✓ Is the Compressor On?..... Yes No
- ✓ Is the Condenser Fan (CFM) On?..... Yes No
- ✓ Is the Heater On? (Clamp an AmpProbe on one leg of the heater contactor to verify) Yes No

Electric Reheat Stop

Adjust the Humidity setpoint to approximately five percent above the current indoor Humidity (Humidistat display should indicate current RH%). After the short delay, the unit will sequence off.

- ✓ Did the Compressor Stop? Yes No
- ✓ Did the Condenser Fan (CFM) Stop? Yes No
- ✓ Did the indoor blower motor (IBM) Stop? Yes No
- ✓ Is the Heater Off? (Clamp an AmpProbe on one leg of the heater contactor to verify) ... Yes No

H. Cooling Mode (Economizer Cooling)

NOTE: If the HVAC system you are testing is Not configured with Economizer Cooling Option, Skip this section of the Start-up / Commissioning Checklist.

- ✓ Has the Economizer Control Board been properly wired to the Control?..... Yes No
- ✓ Has the Economizer Control Board Ambient selections been properly setup? Yes No
- ✓ Has the Economizer Control Board Minimum Opening selection been properly setup?. Yes No
- ✓ Are ambient conditions suitable for Economizer Cooling? (If not, skip this section)..... Yes No

Economizer Cooling Start

If using a standard thermostat, Set the Control to ON, Mode to Cooling, Fan to Auto (other controls, set appropriately for cooling mode).

Adjust the cooling setpoint to approximately two degrees below the current indoor temperature. After the initial start-up delay (.3 to 5 minutes), the unit will sequence on, start cooling. The damper will modulate to maintain 55°F mixed air temperature, thru the supply.

- ✓ Is the indoor blower motor (IBM) On?..... Yes No
- ✓ Is the Compressor Off? (Compressor Should be Off!) Yes No
- ✓ Is the Condenser Fan (CFM) Off? (CFM Should be Off!) Yes No
- ✓ Is the Economizer Damper Open?
(Damper Should be modulating, to control supply air temp.) Yes No

Economizer Cooling (Check and Record Readings)

After about 10 minutes of operating in the cooling mode, check and record the following data points.

All unit panels MUST be in place for proper operation and testing.

Inside Temperature (IAT)	_____ °F
Outside Temperature (OAT)	_____ °F
Return Air Temperature (RAT) db (Should be same temp as IAT)	_____ °F
Return Air Temperature (RAT) wb (used to calculate RH% of Return Air)	_____ °F
Supply Air Temperature (SAT) db (Acceptable Range 55°F (+/- 3°F)	_____ °F
Return Air Temperature (SAT) wb (used to calculate RH% of Supply Air)	_____ °F

Economizer Cooling Stop

Adjust the cooling setpoint to approximately two degrees above the current indoor temperature. The unit will sequence off.

- ✓ Is the Economizer Damper Closed?..... Yes No
- ✓ Is the indoor blower motor (IBM) Off? Yes No

I. Heating Mode (Mechanical Heating Heat Pump)

Close the Compressor (Cooling) circuit breaker. Close the Heating (Heat) circuit breaker. Power will be applied to the thermostat / control device. Setup / Configure the control for the desired settings. Adjust the heating setpoint so there is No demand for heating or cooling. The unit will not be running.

Heating Start (Mechanical Heating Heat Pump)

If using a standard thermostat, Set the Control to ON, Mode to Heat, Fan to Auto (other controls, set appropriately for heating mode). *Note: The reversing valve (Marvair Heat Pumps) is de-energized for "Cooling". The "O" signal from the thermostat is Not Required.*

Adjust the heating setpoint to approximately two degrees above the current indoor temperature. After the initial start-up delay (.3 to 5 minutes), the unit will sequence on, start heating.

- ✓ Is the indoor blower motor (IBM) On?..... Yes No
- ✓ Is the Compressor On?..... Yes No
- ✓ Is the Condenser Fan (CFM) On? (Ambient conditions may be delay CFM)..... Yes No
- ✓ Is the Heater Off? (Clamp an AmpProbe on one leg of the heater contactor to verify) ... Yes No

Heating (Mechanical Heating Heat Pump) (Check and Record Readings)

After about 10 minutes of operating in the heating mode, check and record the following data points.

Inside Temperature (IAT)	_____ °F
Outside Temperature (OAT)	_____ °F
Entering Condenser Air Temperature (Should be same temp as OAT)	_____ °F
Leaving Condenser Air Temperature (Acceptable Range 15° - 20° below OAT)	_____ °F
Return Air Temperature (RAT) db (Should be same temp as IAT)	_____ °F
Return Air Temperature (RAT) wb (used to calculate RH% of Return Air)	_____ °F
Supply Air Temperature (SAT) db (Acceptable Range 15° - 20° above RAT)	_____ °F
Return Air Temperature (SAT) wb (used to calculate RH% of Supply Air)	_____ °F
Compressor Amps (L1)	_____ °F
Compressor Amps (L2)	_____ °F
Compressor Amps (L3)	_____ °F

Auxiliary Heat (ODT)

While the system is operating in “Mechanical Heating Mode”. Activate Auxiliary Heat (ODT).

* Your unit may be configured with an outdoor thermostat configured as “Auxiliary Heat” or “Mechanical Heat Lockout”, or No outdoor thermostat. *

Do Not change the temperature setpoint on the thermostat / control. Simply adjust the ODT setpoint to approximately four degrees below the current outdoor temperature. After the short delay, the unit will activate Auxiliary Heat, start heating with Both Mechanical heat and Electric heat. Notice: system did not turn off. The Only change that occurred is “Electric Heat” turned On. *Note: The “S” Circuit (Marvair Heat Pump control board) must be set to “No”, to allow Auxiliary Heat.*

- ✓ Is the indoor blower motor (IBM) On? Yes No
- ✓ Is the Compressor On? Yes No
- ✓ Is the Condenser Fan (CFM) On? Yes No
- ✓ Is the Heater On? (Clamp an AmpProbe on one leg of the heater contactor to verify).... Yes No

Mechanical Heat Lockout ODT (Electric Heat ONLY)

While the system is operating in “Mechanical Heating Mode”. Activate Mechanical Heat Lockout (ODT).

* Your unit may be configured with an outdoor thermostat configured as “Auxiliary Heat”, “Mechanical Heat Lockout”, or No outdoor thermostat. *

Do Not change the temperature setpoint on the thermostat / control. Simply adjust the ODT setpoint to approximately four degrees below the current outdoor temperature. After the short delay, the unit will activate Mechanical Heat Lockout, start heating with Only Electric heat. Notice: system did not turn off. “Mechanical Heat” turned Off and “Electric Heat” turned On. *Note: The “S” Circuit (Marvair Heat Pump control board) must be set to “Yes”, to allow Mechanical Heat Lockout.*

- ✓ Is the indoor blower motor (IBM) On? Yes No
- ✓ Is the Compressor Off? Yes No
- ✓ Is the Condenser Fan (CFM) Off? Yes No
- ✓ Is the Heater On? (Clamp an AmpProbe on one leg of the heater contactor to verify).... Yes No

Heating (Check and Record Readings)

After about 10 minutes of operating in the heating mode, check and record the following data points.

Inside Temperature (IAT)	_____ °F
Outside Temperature (OAT)	_____ °F
Return Air Temperature (RAT) db (Should be same temp as IAT)	_____ °F
Return Air Temperature (RAT) wb (used to calculate RH% of Return Air)	_____ °F
Supply Air Temperature (SAT) db (Acceptable Range 15° - 20° below RAT)	_____ °F
Return Air Temperature (SAT) wb (used to calculate RH% of Supply Air)	_____ °F
Heater Contactor Amps (HCAL1)	_____ °F
Heater Contactor Amps (HCAL2)	_____ °F
Heater Contactor Amps (HCAL3)	_____ °F
Heater Circuit Volts (L1&L2)	_____ °F
Heater Circuit Volts (L1&L3)	_____ °F
Heater Circuit Volts (L2&L3)	_____ °F

- ✓ Calculate Heater kW

Single Phase Units

Heater kW = (HCAL1*L1&L2)/1000 = _____ kW.

Example: $\frac{HCAL1 * L1\&L2}{1000}$

Measured Voltage: L1&L2 = 241 Volts

Measured Amperage: L1 = 20.7 Amps

$4988.7 / 1000 = 4.99\text{kW (5kW)}$

Three Phase Units

Heater kW = (HCAL1*L1&L2) + (HCAL2*L1&L3) + (HCAL3*L2&L3)/1000 = _____ kW.

Example: $\frac{(HCAL1 * L1\&L2) + (HCAL2 * L1\&L3) + (HCAL3 * L2\&L3)}{1000}$

Measured Voltage: L1&L2 = 241 Volts

Measured Amperage: L1 = 8.28 Amps

1995.48

Measured Voltage: L1&L3 = 243 Volts

Measured Amperage: L1 = 8.22 Amps

1997.46

Measured Voltage: L1&L2 = 235 Volts

Measured Amperage: L1 = 8.57 Amps

2013.95

$6006.89 / 1000 = 6.01\text{kW (6kW)}$

Outdoor Thermostat Set Point ODT

Adjust the ODT setpoint to the temperature appropriate for your application (either “Auxiliary Heat” or “Mechanical Heat Lockout”). If you need assistance selecting the proper temperature contact your HVAC system designer responsible for the application. After adjusting the ODT for your application, the HVAC system will go back to Mechanical Cooling. *Note: The range of the Outdoor Thermostat is 0°F to 50°F.*

- ✓ Is the indoor blower motor (IBM) On?.....Yes No
- ✓ Is the Compressor On?.....Yes No
- ✓ Is the Condenser Fan (CFM) On? (Ambient conditions may be delay CFM).....Yes No
- ✓ Is the Heater Off? (Clamp an AmpProbe on one leg of the heater contactor to verify) ...Yes No

Heating Mode Stop (Mechanical Heating Heat Pump)

Adjust the heating setpoint to approximately two degrees below the current indoor temperature. The unit will sequence off, stop heating.

- ✓ Did the Compressor stop?.....Yes No
- ✓ Did the Condenser Fan (CFM) stop?.....Yes No
- ✓ Did the indoor blower motor (IBM) Stop?Yes No

